

Surgical Management of the Axilla

Jean-Francois Boileau, MD, MSc, FRCSC

Surgical Oncologist, Montreal Jewish General Hospital Segal Cancer Centre

Associate Member, Department of Oncology, McGill University

Vancouver, October 2014

Disclosures

- Institution received funding from the Quebec Breast Cancer foundation, Cancer Research Society, Week-end to End Women's Cancers, Montreal Jewish General Segal Cancer Centre for the conduct of the SN FNAC trial.
- Speaking honoraria from Roche, Novartis, Amgen and Genomic Health.
- Travel support from Roche and GSK.
- Institution received research funding from Roche and Rna Diagnostics inc.

Objectives to be covered

- Is it considered appropriate to do an axillary node dissection in a clinically negative axilla?
 - Remote communities
 - Large tumors
 - Post neoadjuvant therapy
- What is the current management of a positive sentinel node?
 - Discuss Z0011
 - Discuss newer evidence since Z0011
 - After total mastectomy
- Current Indications for axillary node dissection.
- How does the multidisciplinary team work in Quebec?

Management of the Axilla

A short history

We've come a long way



William Halsted 1895



«There is definite more or less uninterrupted or quite uninterrupted connection between the original focus and the outlying deposits of cancer... »

Halstead Mastectomy

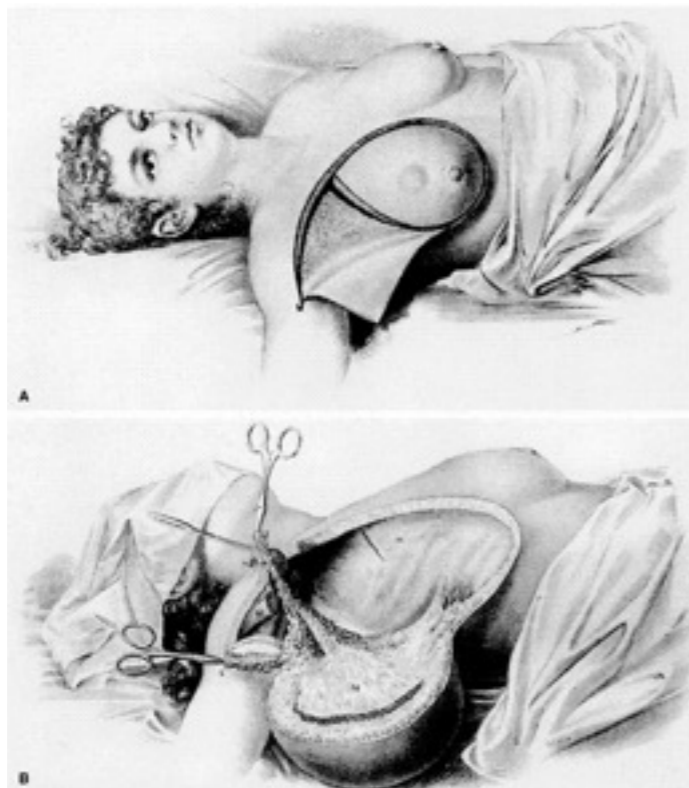

- “Extended radical” and “Super-radical” mastectomies were being considered to improve the treatment of breast cancer.
- The recommended surgery for breast cancer until the 1970’s.

The Revolution: Dr Bernard Fisher & the NSABP

- “Breast cancer is a systemic disease, and expansive loco-regional therapy is unlikely to improve survival”
- Brought clinical trials and statistical methodology to breast cancer research.
- NSABP B-01, B-04, B-06, etc.

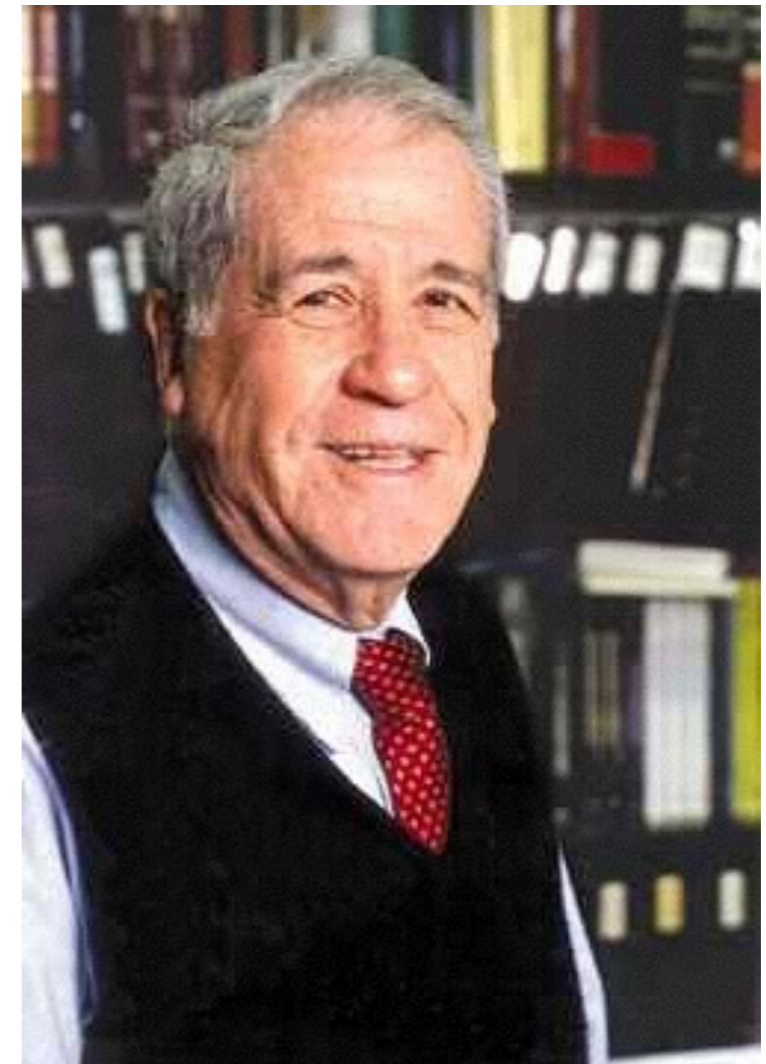

Trials of less surgery

NSABP B-04 Schema

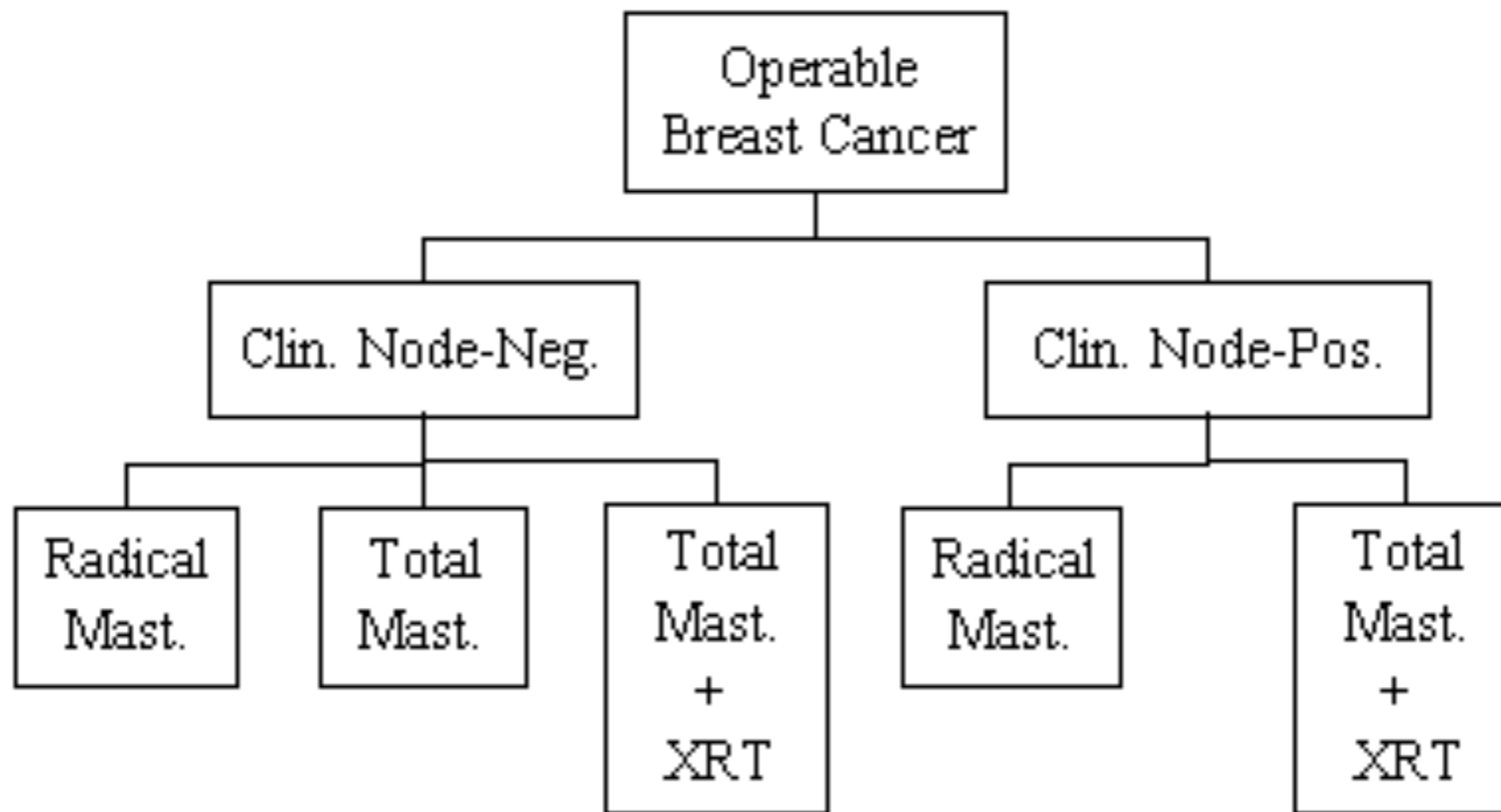

Survival; NSABP Protocol B-04

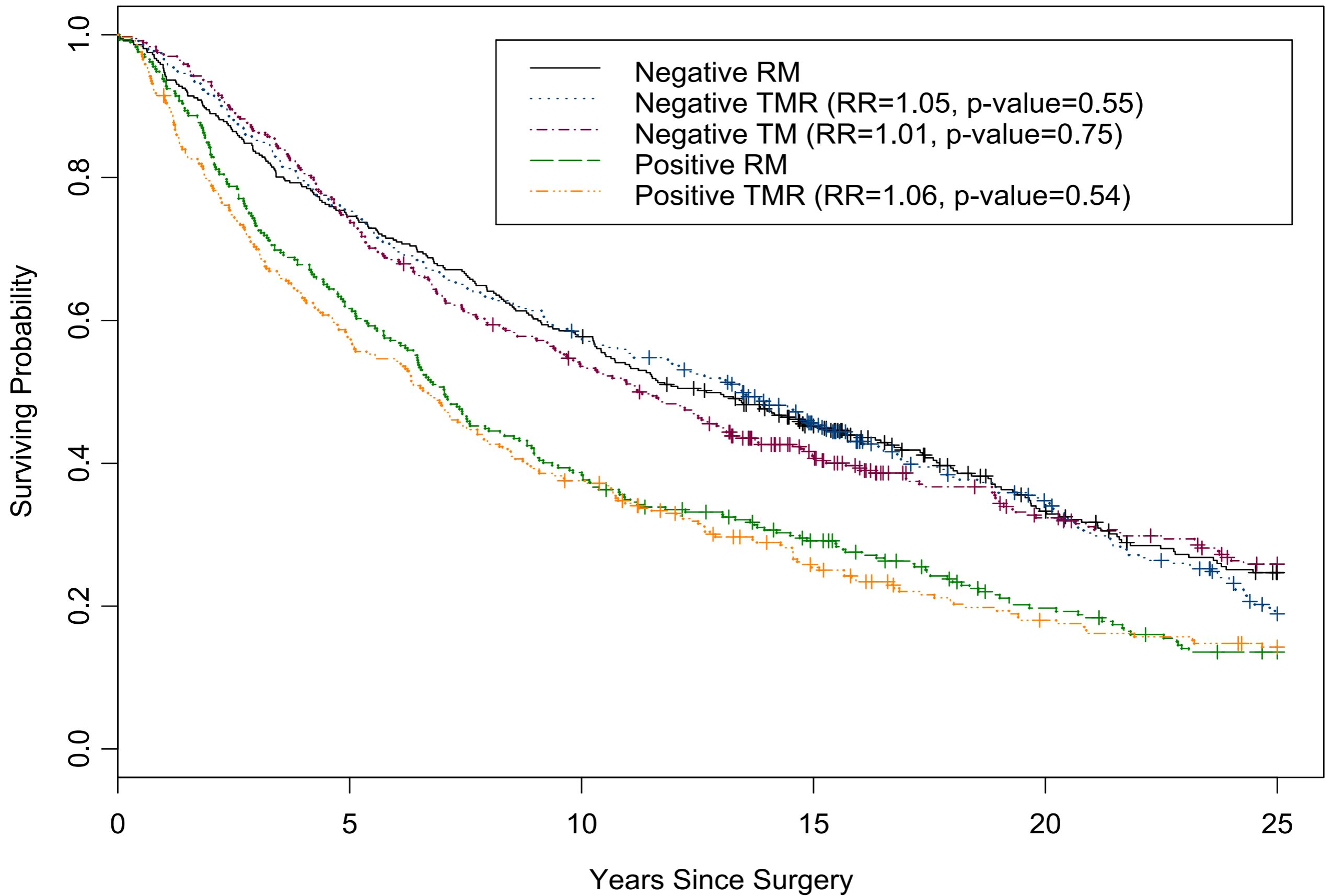

NSABP B-04 Events

TABLE 1. DISTRIBUTION OF ALL FIRST EVENTS ACCORDING TO TREATMENT GROUP.

EVENT	WOMEN WITH NEGATIVE NODES			WOMEN WITH POSITIVE NODES		ALL WOMEN (N=1665)
	RADICAL MASTECTOMY (N=362)	TOTAL MASTECTOMY (N=365)	TOTAL MASTECTOMY PLUS RADIATION THERAPY (N=352)	RADICAL MASTECTOMY (N=292)	TOTAL MASTECTOMY PLUS RADIATION THERAPY (N=294)	
	number (percent)					
Any event	281 (78)	287 (79)	292 (83)	254 (87)	258 (88)	1372 (82)
Any recurrence*	135 (37)	156 (43)	131 (37)	165 (57)	168 (57)	755 (45)
Local	19 (5)	26 (7)	5 (1)	23 (8)	8 (3)	81 (5)
Regional	15 (4)	23 (6)	15 (4)	22 (8)	33 (11)	108 (6)
Distant	101 (28)	107 (29)	111 (32)	120 (41)	127 (43)	566 (34)
Contralateral breast cancer	19 (5)	26 (7)	32 (9)	13 (4)	15 (5)	105 (6)
Second primary cancer†	23 (6)	19 (5)	28 (8)	12 (4)	17 (6)	99 (6)
Dead, no evidence of cancer	104 (29)	86 (24)	101 (29)	64 (22)	58 (20)	413 (25)
Alive, event-free	81 (22)	78 (21)	60 (17)	38 (13)	36 (12)	293 (18)

*Data are for any recurrence other than a recurrence in the contralateral breast.

†Data are for any second primary cancer other than breast cancer.

*** Clinically significant axillary disease after total mastectomy alone = 18.6%**

NSABP B-06

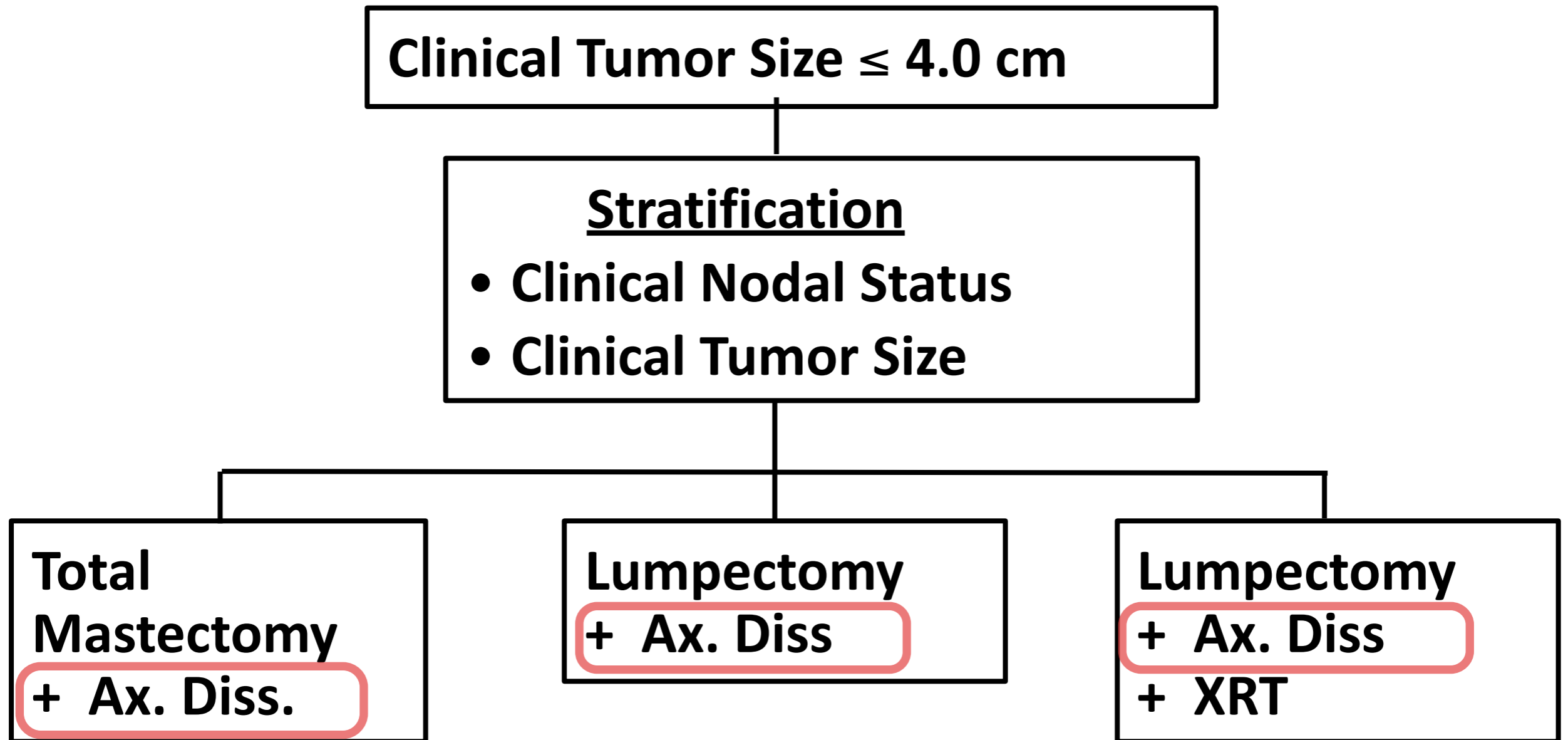

All patients with histology positive axillary nodes receive L-PAM + 5 FU.
Total mastectomy performed in event of ipsilateral breast tumor recurrence.

Lessons Learned

- Less surgery is OK
- High rate of clinically significant axillary disease if no axillary treatment
- Patients with clinically positive nodes had similar outcome whether they had ALND or XRT



Why do an ALND?

- Improve regional control
- Improve survival
- Obtain information to guide systemic therapy
- Obtain information to guide radiotherapy
- Obtain information about prognosis

Why do an ALND?

- Improve regional control 
- Improve survival
- Obtain information to guide systemic therapy
- Obtain information to guide radiotherapy
- Obtain information about prognosis

Why do an ALND?



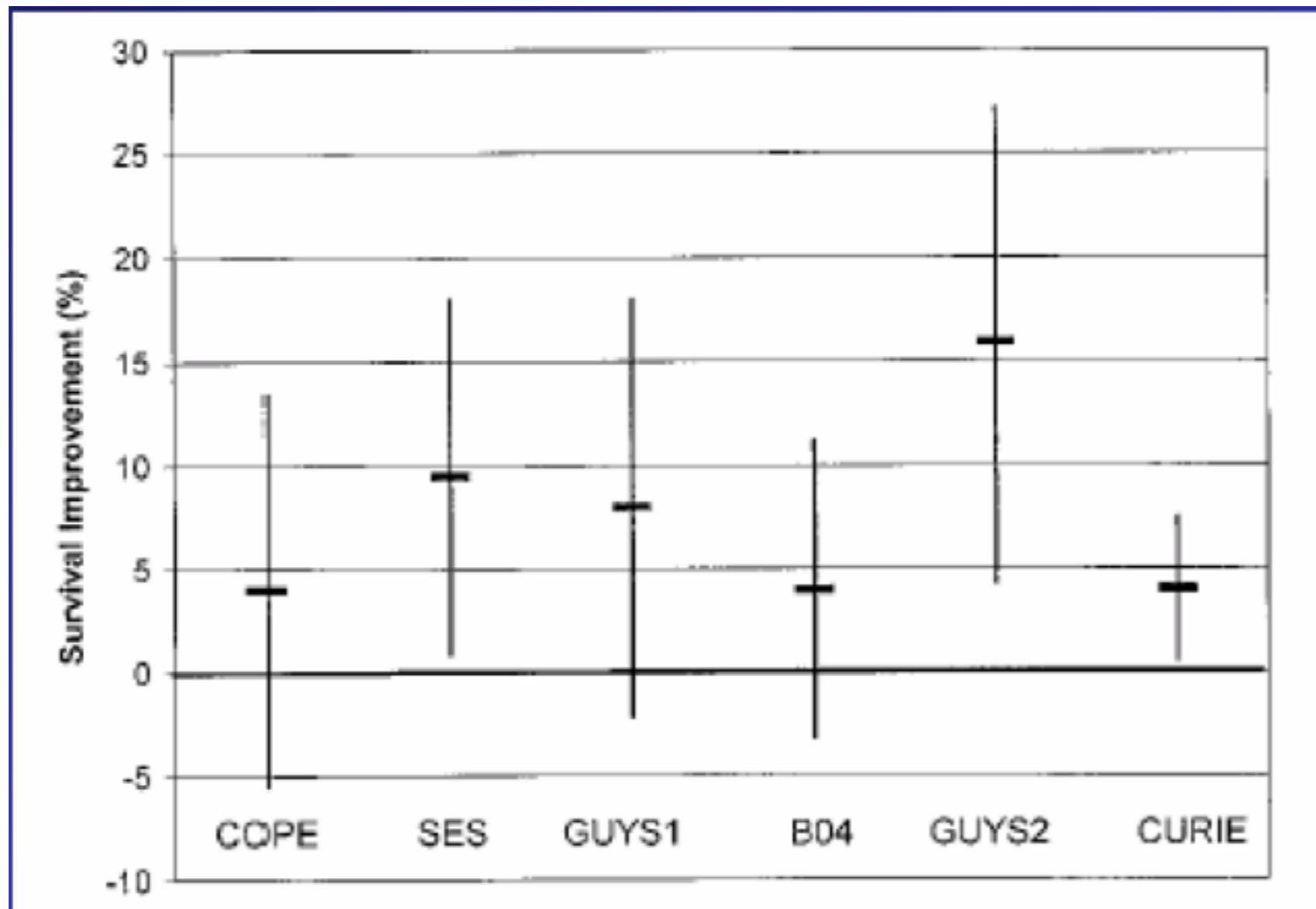

- Improve regional control 
- Improve survival ?/ 
- Obtain information to guide systemic therapy
- Obtain information to guide radiotherapy
- Obtain information about prognosis

Potential survival advantage of axillary node dissection

Overall 5.4% (95% CI = 2.7-8.0%, probability of survival benefit > 99.5%)



Why do an ALND?

- Improve regional control 
- Improve survival ?/ 
- Obtain information to guide systemic therapy 
- Obtain information to guide radiotherapy 
- Obtain information about prognosis 

Indications for ALND v.1

- All invasive breast cancers

The problem with ALND: associated morbidities

- Lymphedema
- Limited arm movement / frozen shoulder
- Numbness
- Pain
- Cording
- etc...



ALMANAC Trial

Sentinel node biopsy

A new **gold standard** for patients with clinically negative nodes

NSABP B-32

Operable Breast Cancer
Clinically Negative Nodes

**1.5% had tumors >4cm*

Stratification

- Age
- Clinical Tumor Size
- Type of Surgery

*False Negative Rate:
9.8%

Sentinel Node Biopsy



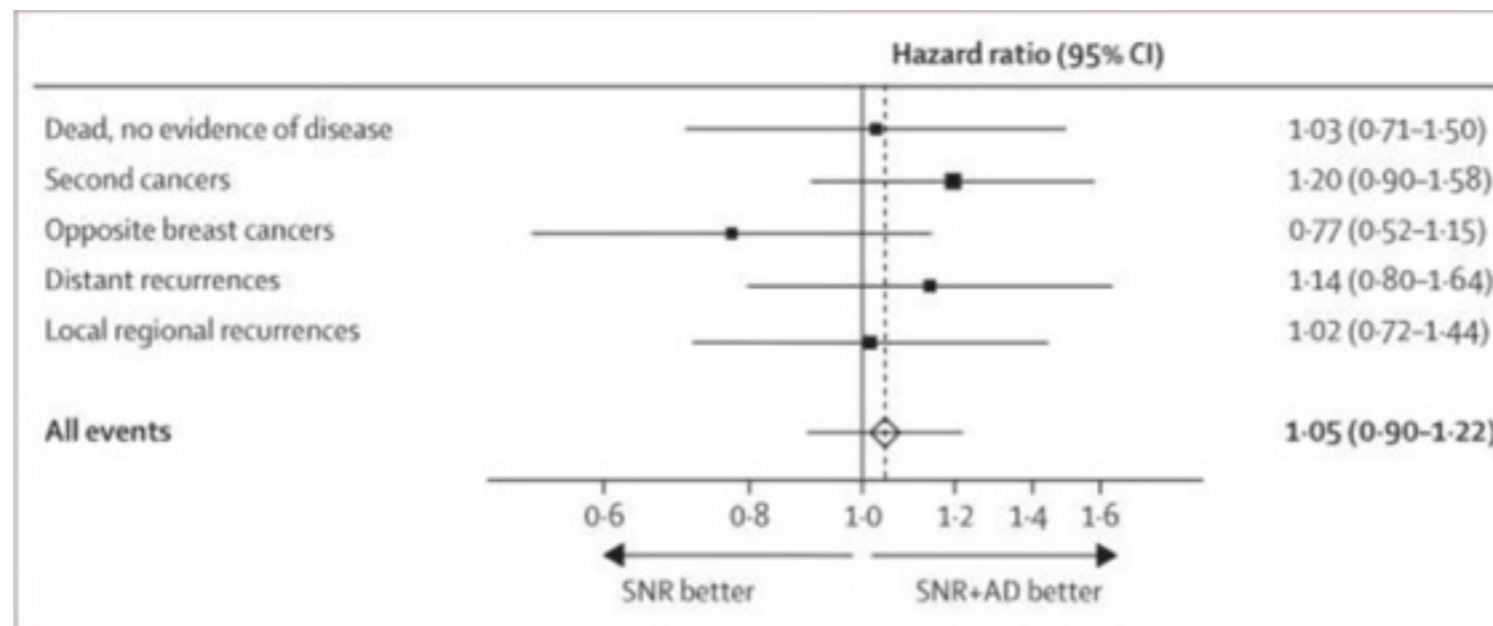
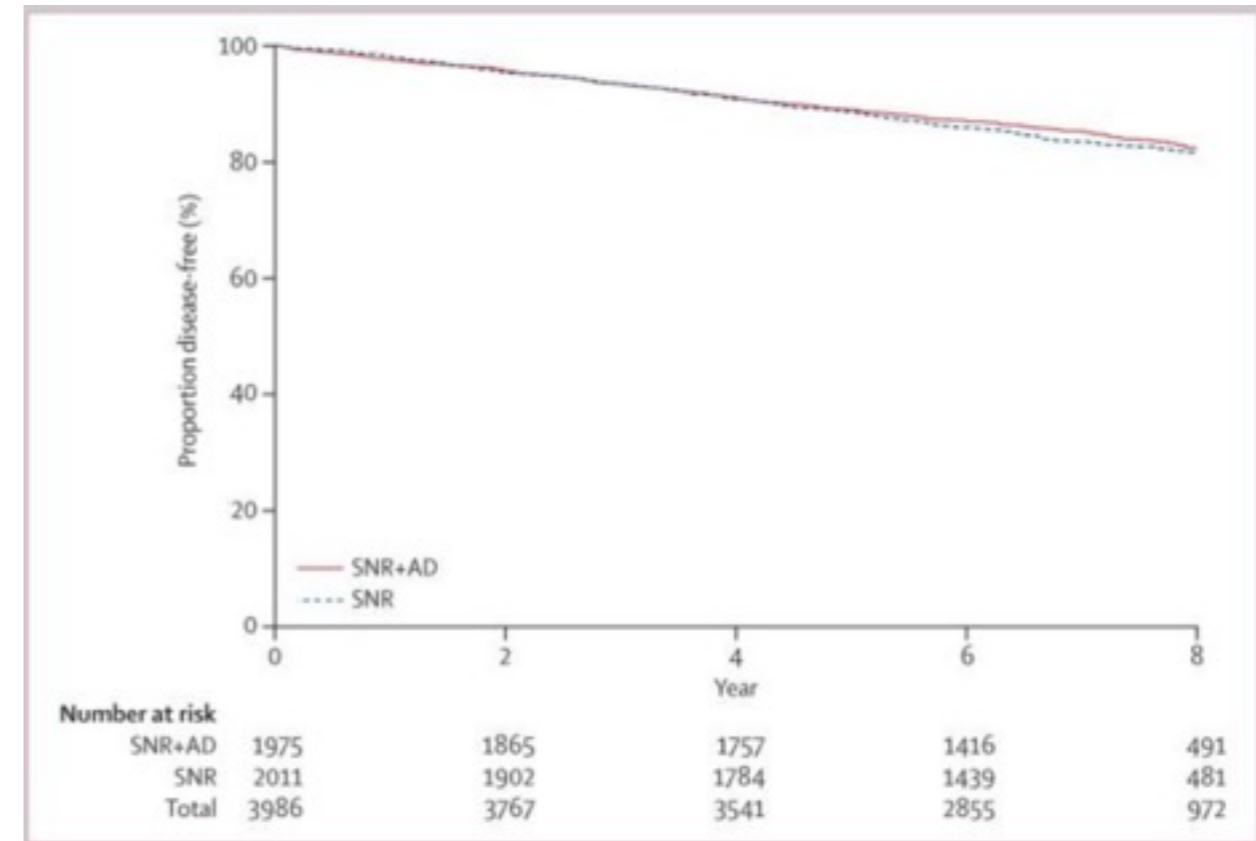
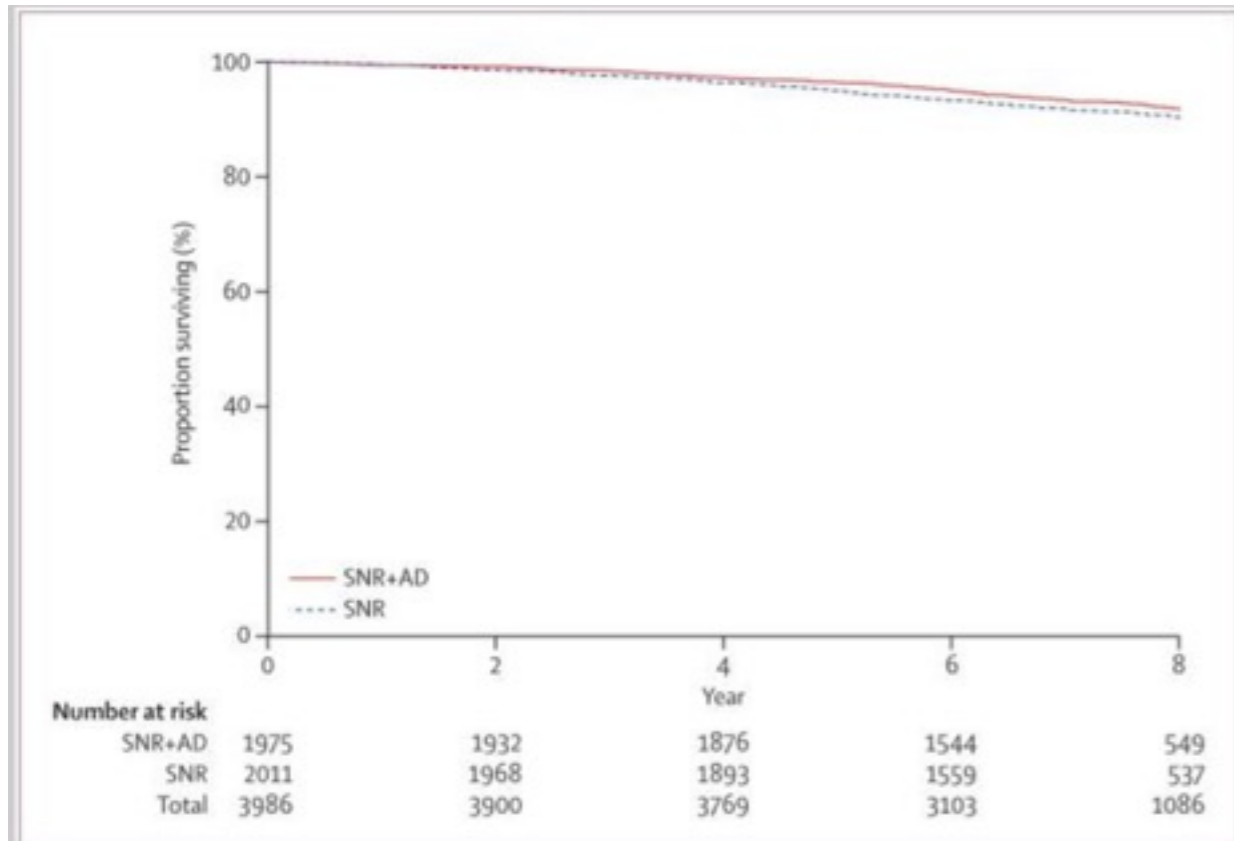

Axillary Node Dissection
if Sentinel Node-Positive

Sentinel Node Biopsy
Followed by
Axillary Node Dissection

NSABP B-32



Why do a SNB?

- Same regional control 
- Same survival 
- Obtain information to guide systemic therapy 
- Obtain information to guide radiotherapy 
- Obtain information about prognosis 

SLNB after Neoadjuvant Chemotherapy in Node Negative Patients

Who	Where	What	N	Identification Rate False Negative Rate
Mamounas, E.P.	J Clin Oncol 2005	Unplanned NSABP B-27 Subgroup	326	IR (275/326) = 84.4%; FN (12/97) = 12.4%
Gimbergues, P.	Ann Surg Oncol 2008	Series	82	IR (77/82) = 93.9% FN (0/29) = 0%
Kinoshita, T.	Breast Cancer 2007	Series, node negative NAC	104	IR (97/104) = 93.4%; FN (4/40) = 10.0%
Classe, J.M.	J Clin Oncol 2005	Series	130	IR (123/130) = 94.6%; FN (3/40) = 7.5%

Indications for ALND v.2

- Patients that are **not eligible for SNB:**
 - **T4/Inflammatory** breast cancer
 - Clinically/biopsy proven **node positive disease**
- Patients with **positive SNs**

Objectives

- Is it considered appropriate to do an axillary node dissection in a clinically negative axilla? **SENTINEL NODE BIOPSY IS THE GOLD STANDARD.**
 - Remote community: **PATIENT NEEDS TO BE INFORMED OF THE ALTERNATIVES AND DECIDE: REFERRAL/TRAVEL VS INCREASED MORBIDITY.**
 - Large tumors: **ACCEPTABLE UNLESS INFLAMMATORY.**
 - Post neoadjuvant therapy: **ACCEPTABLE AND RECOMMENDED.**

Positive sentinel node biopsy

Should we always do an ALND?

ACOSOG Z0011

Non-inferiority:

If 5 yr survival for SNB is not less than 75% of that seen with ALND ...

Excluded:

- Mastectomy
- Neoadjuvant therapy
- Extracapsular invasion (>2mm)

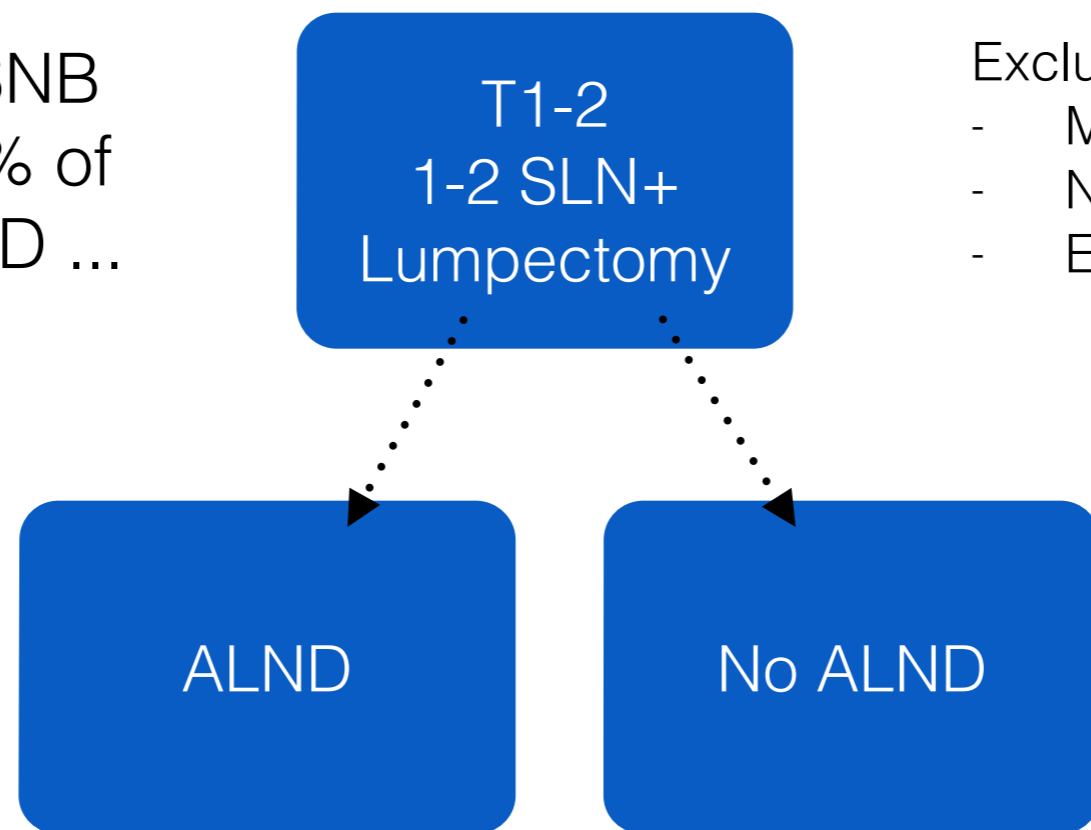

Rads Tangential

Overall Survival

Planned N=1900

ACOSOG Z0011

Non-inferiority:

Accept as non-inferior
a reduction of mortality
from 80% to 60% ...

Excluded:

- Mastectomy
- Neoadjuvant therapy
- Extracapsular invasion (>2mm)

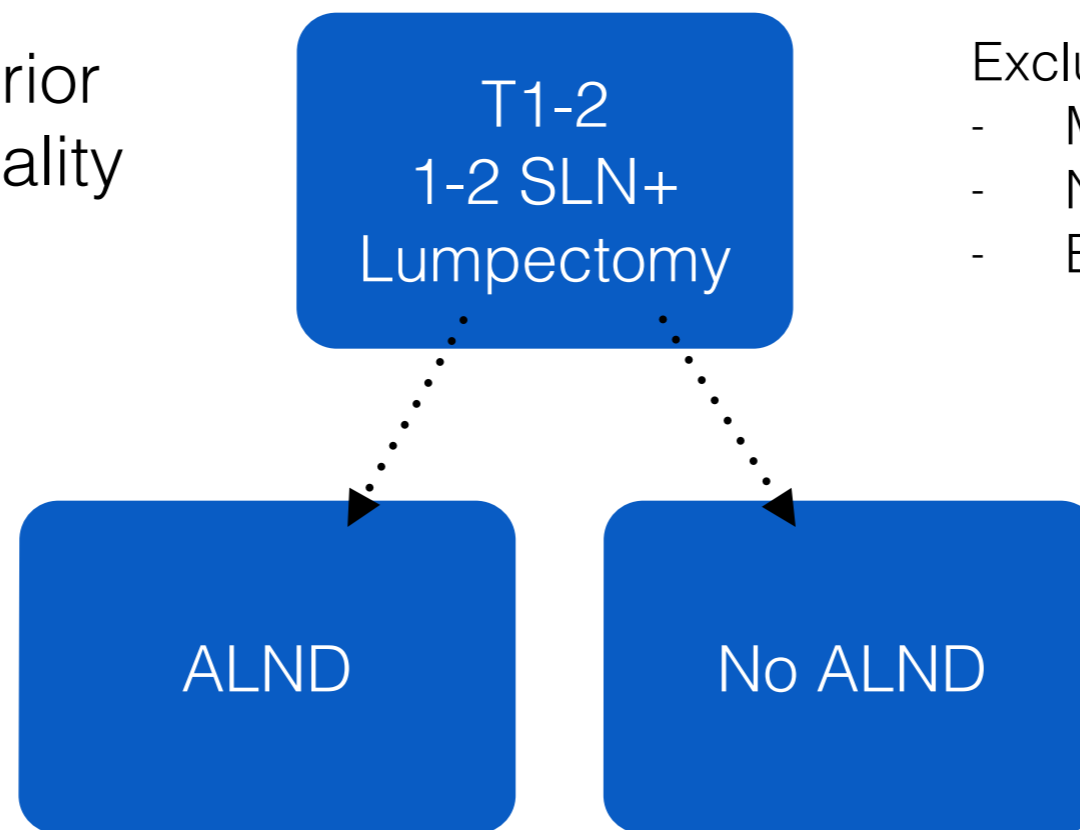

Rads Tangential

Overall Survival

Planned N=1900

ACOSOG Z011

Figure 2. Survival of the ALND Group Compared With SLND-Alone Group

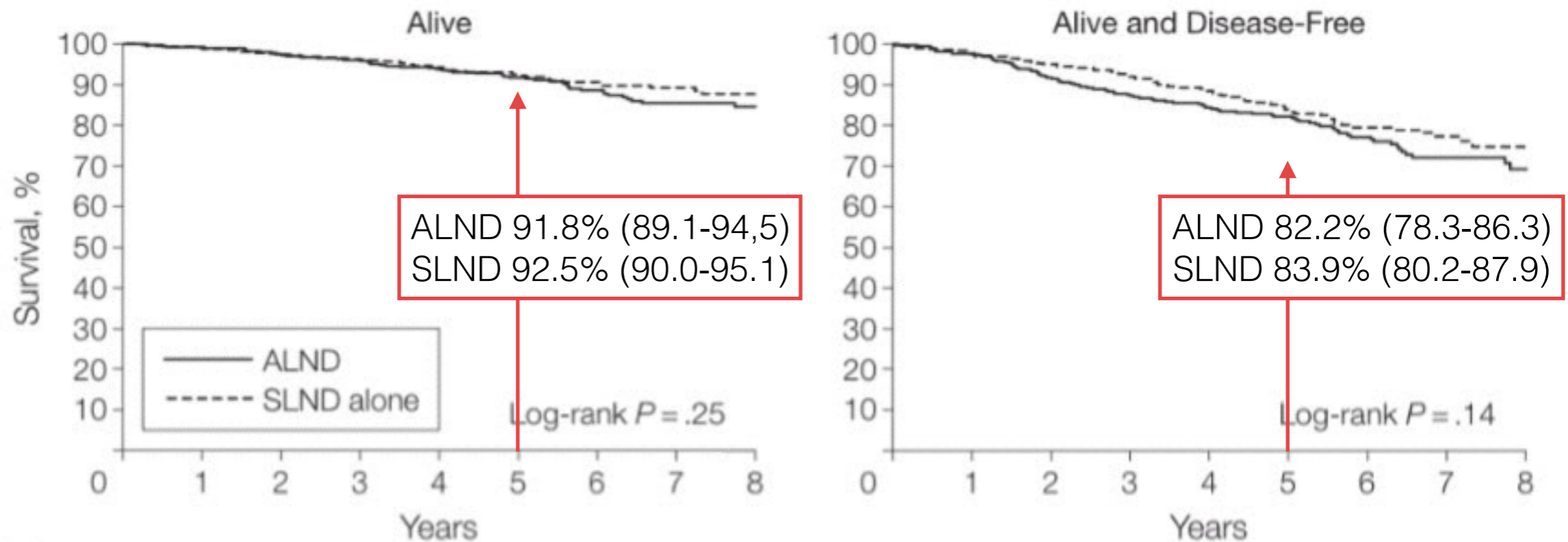

No. at risk

ALND	420	408	398	391	378	313	223	141	74	420	369	335	310	286	226	152	83	37
SLND alone	436	421	411	403	387	326	226	142	74	436	395	363	337	307	231	147	81	36

ALND indicates axillary lymph node dissection; SLND, sentinel lymph node dissection.

N=856/1900

ACOSOG Z0011:

Perfect guide on how to do a bad non-inferiority trial

- ✓ Compliance/adherence
- ✓ Withdrawals
- ✓ Inclusion/exclusion criteria
- ✓ Losses to follow-up
- ✓ Missing data
- ✓ Any deviation from protocol
- ✓ ITT analysis adds bias

Study must be even more closely examined if assessments of any of the above reveal inconsistencies



... But ...

- Many patients with positive sentinel node biopsy do have a good prognosis and can benefit from what we learned from Z0011.
- It is likely that if the trial was better designed and executed, the results would be identical.
- When we do lumpectomy, we know that we leave disease behind that is treated with radiation -- why would leaving clinically undetected disease in the axilla be any different?

IBCSG 23-01

SLN *micromet*/no ALND

Event	ALND n=464	No ALND n=467
Local	2%	2%
Regional	0.2%	1%
Distant	7%	5%
Death	4%	4%

Indications for ALND v.3

- Patients that are not eligible for SNB:
 - T4/Inflammatory breast cancer
 - Clinically/biopsy proven node positive disease
- Patients with positive SNs **that do not fit the Z0011 criteria:**
 - **T3**
 - **Mastectomy**
 - **3+ positive SNs**
 - **SNs with extracapsular invasion > 2mm**
 - **Patients who have positive SNs after neoadjuvant therapy**

SNB, ALND and RNI

Intertwined options for best local control



NCIC-CTG MA.20

An Intergroup Trial of Regional Nodal Irradiation (RNI) in Early Breast Cancer

TJ Whelan, I Olivotto, I Ackerman, JW Chapman, B Chua, A Nabid, KA Vallis, JR White, P Rousseau, A Fortin, LJ Pierce, L Manchul, P Craighead, MC Nolan, J Bowen, DR McCready, KI Pritchard, MN Levine, and W Parulekar

On behalf of the NCIC-CTG, TROG, RTOG, SWOG, NCCTG, and NSABP Cooperative Groups

NCIC Clinical Trials Group
INCC Groupe des essais cliniques



Study Design

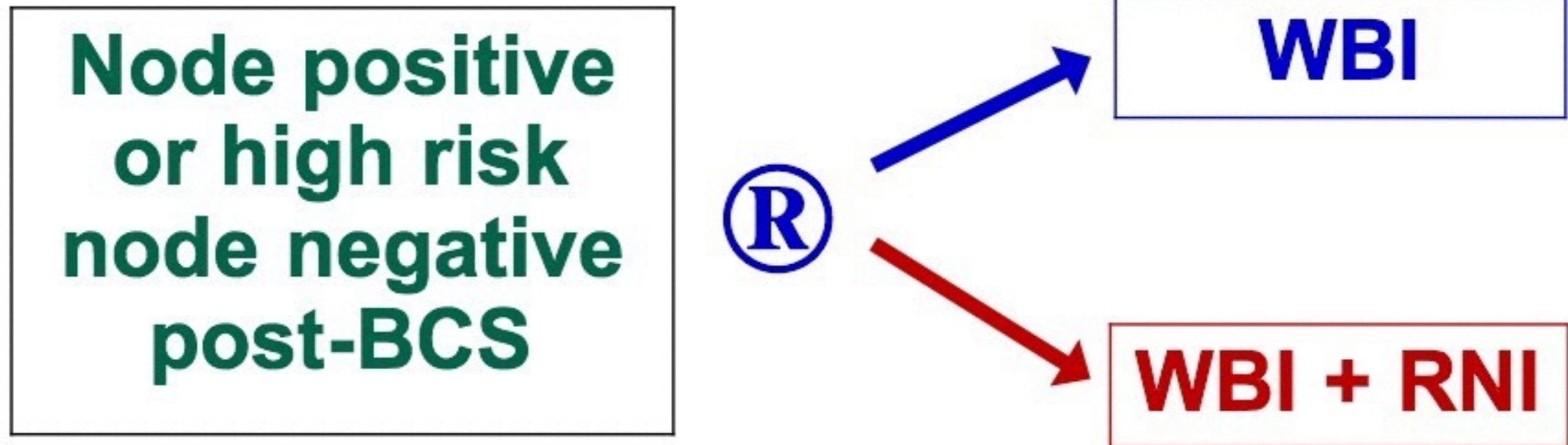

Stratification

- § Axillary nodes removed (<10, ≥10)
- § Positive axillary nodes (0, 1-3, >3)
- § Chemotherapy (anthracycline, other, none)
- § Endocrine therapy (yes, no)

Disease Free Survival

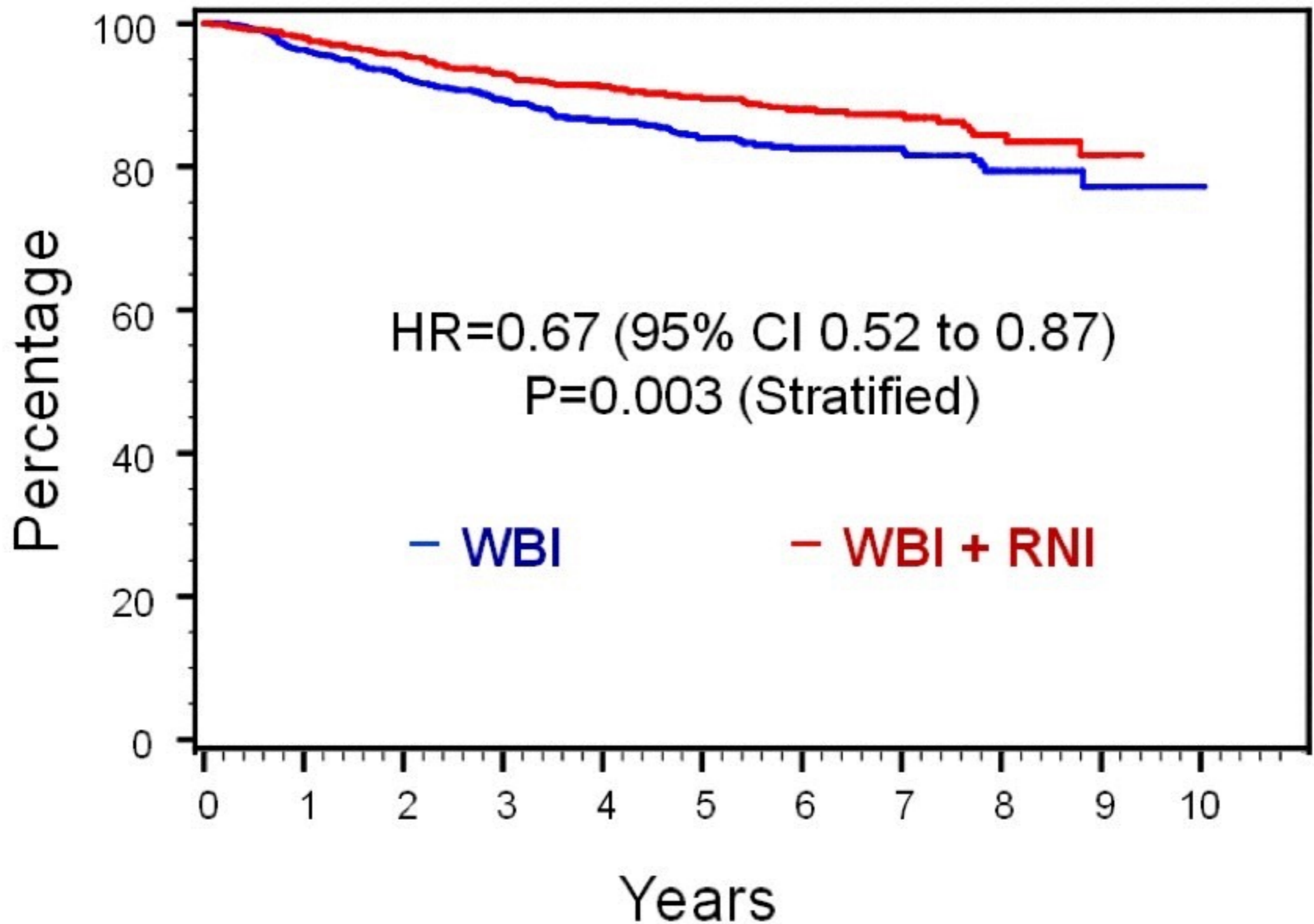

Adverse Events*

Grade ≥ 2

Grade 	WBI n=927				WBI + RNI n=893				P Value
	2	3	4/5	Any	2	3	4/5	Any	
Acute									
Radiation Dermatitis	349	23	-	40%	397	45	-	50%	<0.001
Pneumonitis	2	-	-	0.2%	12	-	-	1.3%	0.01
Delayed									
Lymphedema	34	3	1	4%	61	4	-	7%	0.004

*NCI Common Toxicity Criteria v.2 1998

Implications

- Women with node +ve breast cancer are treated WBI following BCS
- Women with large primary tumours or >3 +ve nodes are also offered RNI
- Results from MA.20 suggest that all women with node +ve disease be offered RNI provided they are made aware of the associated toxicities

Implementation of MA.20 and use of RNI will decrease the use of ALND

- Patients with node positive sentinel nodes are likely to receive RNI regardless of the axillary operation.
- We know that ALND + RNI increases the risk of lymphedema.
- In the presence of RNI, surgeons will limit the use of ALND.
- In post-mastectomy patients that are treated with RNI, can we omit ALND?

The final blow...



Radiotherapy or surgery of the axilla after a positive sentinel node in breast cancer patients: final analysis of the EORTC AMAROS trial

By the EORTC Breast Cancer Group and
Radiation Oncology Group

In collaboration with the Dutch BOOG Group
and ALMANAC Trialists' Group

Emiel J.T. Rutgers

The Netherlands Cancer Institute, Amsterdam

AMAROS Trial

Trial design

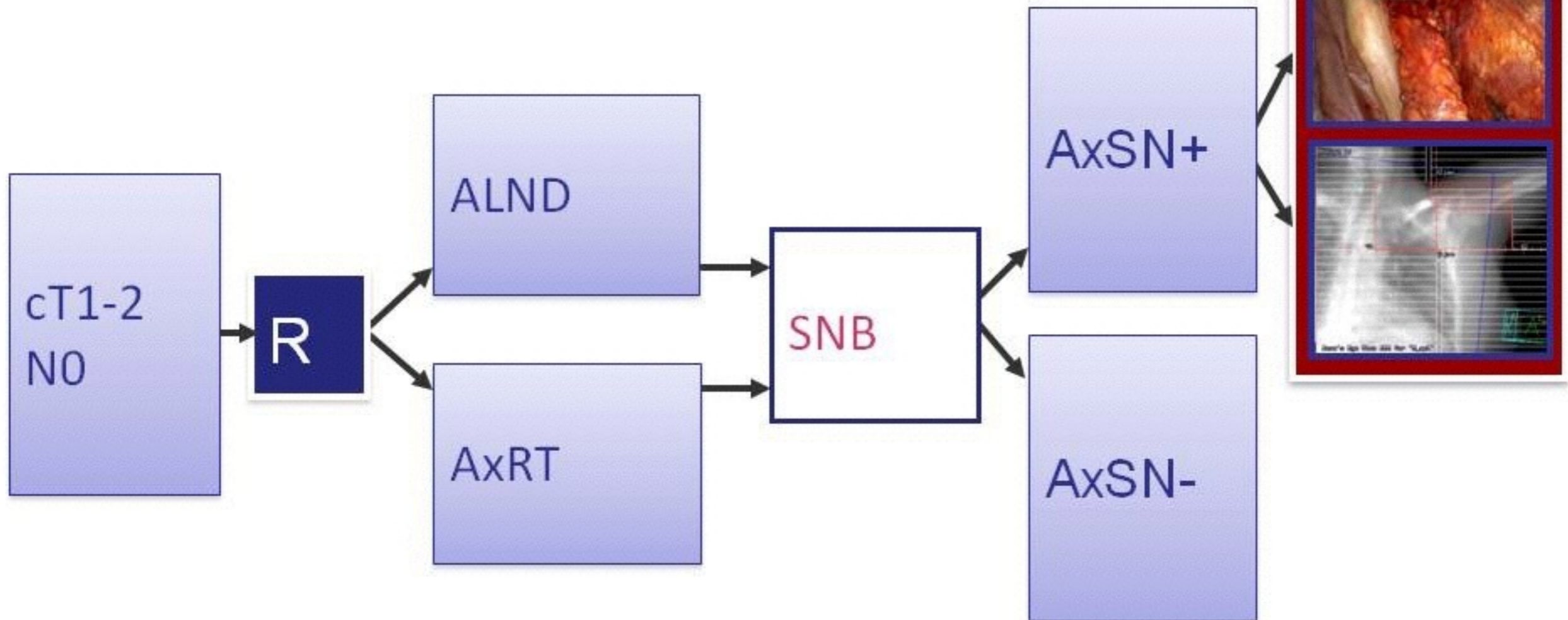

Stratification: institution

Adjuvant systemic therapy by choice

Eligibility Criteria

Inclusion

- Invasive breast cancer 0.5-5 cm
- Clinically N0
- BCT or mastectomy
- Any age
- Informed consent

Exclusion

- Multicentric disease
- Neoadjuvant systemic treatment
- Previous axillary treatment
- Prior malignancy

Baseline treatment

	ALND (744 pts)	ART (681 pts)
Breast surgery		
BCS	81.9 %	81.8 %
Mastectomy	17.1 %	17.8 %
Systemic treatment		
chemotherapy	60.9 %	61.3 %
hormonal therapy	78.6 %	77.1 %
immunotherapy	6.0 %	6.4 %
no systemic treatment	9.0 %	9.4 %
RT breast/chest wall	84.8 %	87.7 %

Endpoints and statistical design

Primary: 5-years axillary recurrence free rate

Non inferiority hypothesis (design):

- assumption: ALND 98%; ART >96%
- one-sided log-rank; alpha = 0.05; power = 80%
- 52 events needed

Secondary:

- **Efficacy**: OS and DFS
- **Safety**: shoulder function, lymphedema, QoL

AMAROS Trial

Axillary recurrence rate

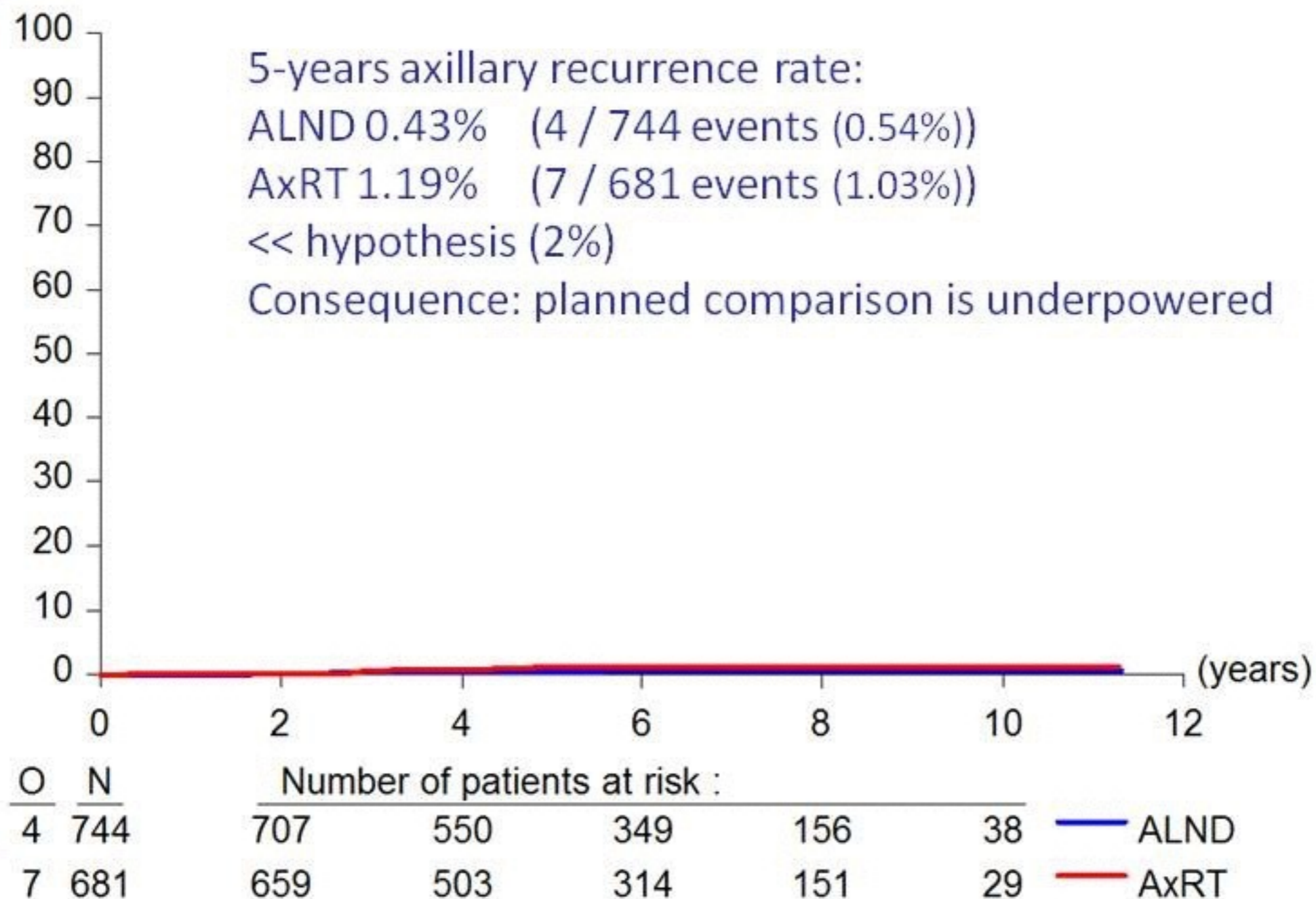

AMAROS Trial

Disease-free survival

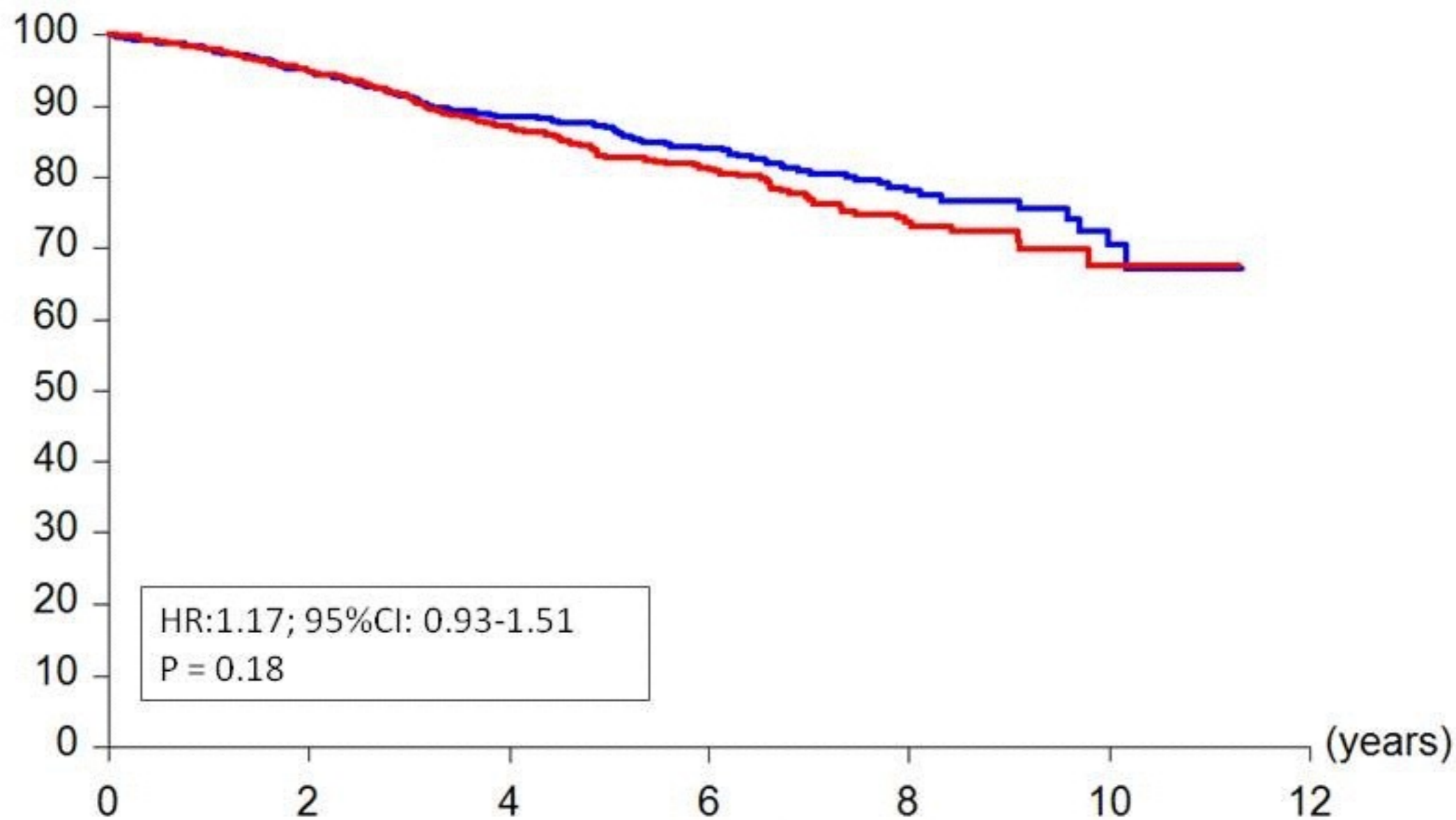

O	N	Number of patients at risk :					
124	744	686	511	322	140	33	— ALND
134	681	633	468	284	131	24	— AxRT

AMAROS Trial

Overall survival

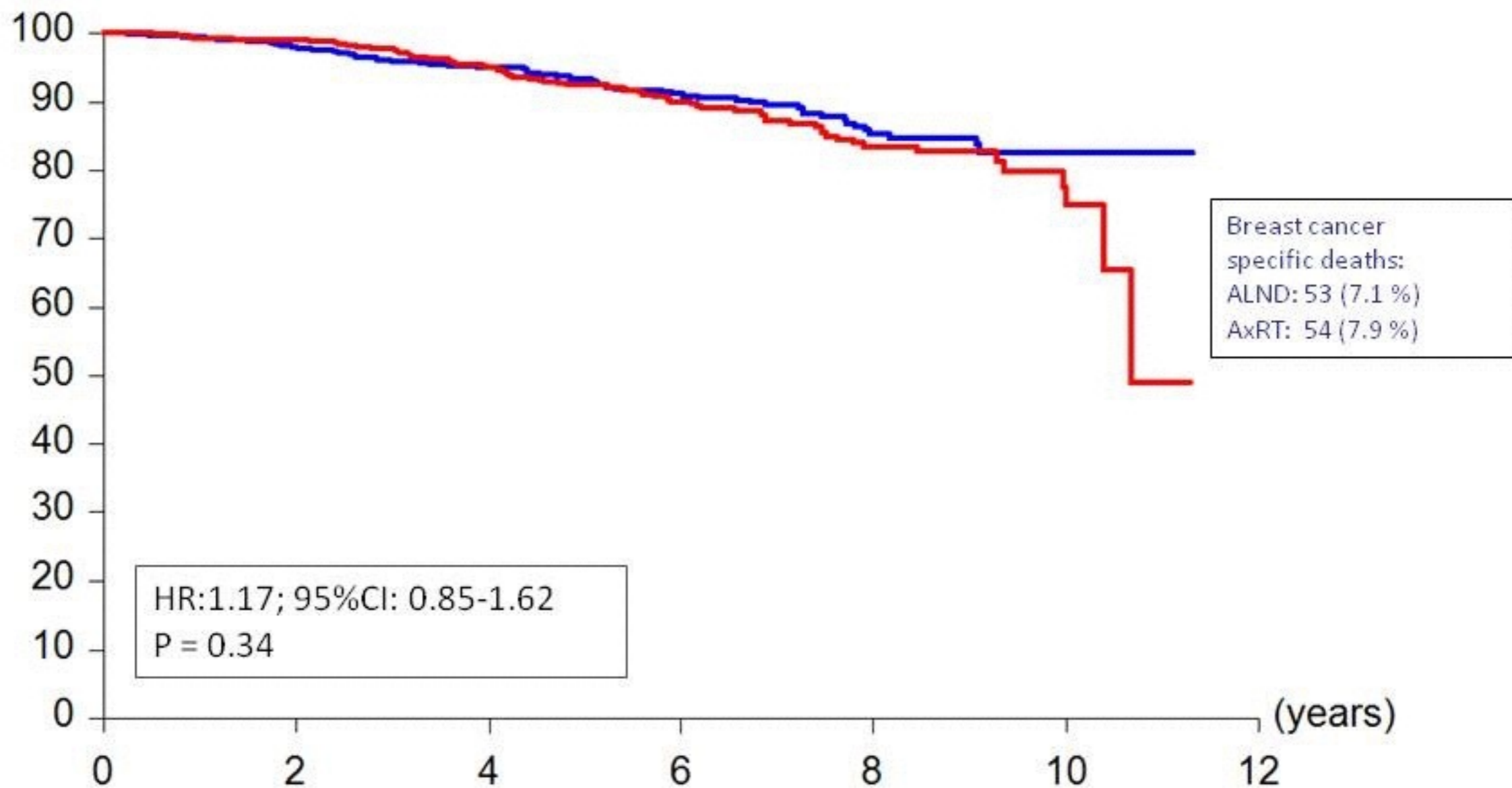

O	N	Number of patients at risk :					
71	744	708	552	352	157	38	— ALND
76	681	661	505	316	151	29	— AxRT

AMAROS Trial

Lymphedema: clinical observation and/or treatment

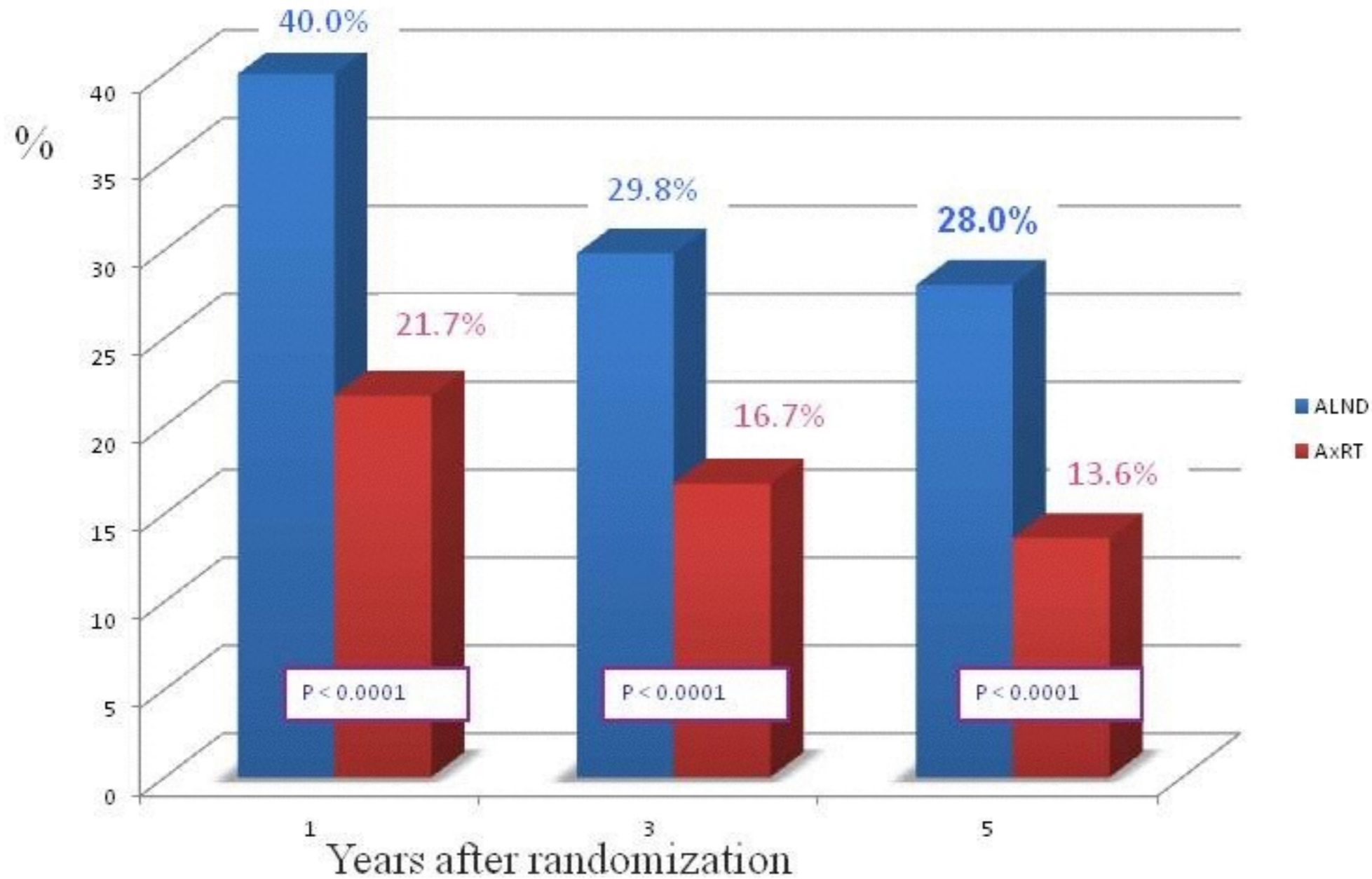

Lymphoedema: clinical observation

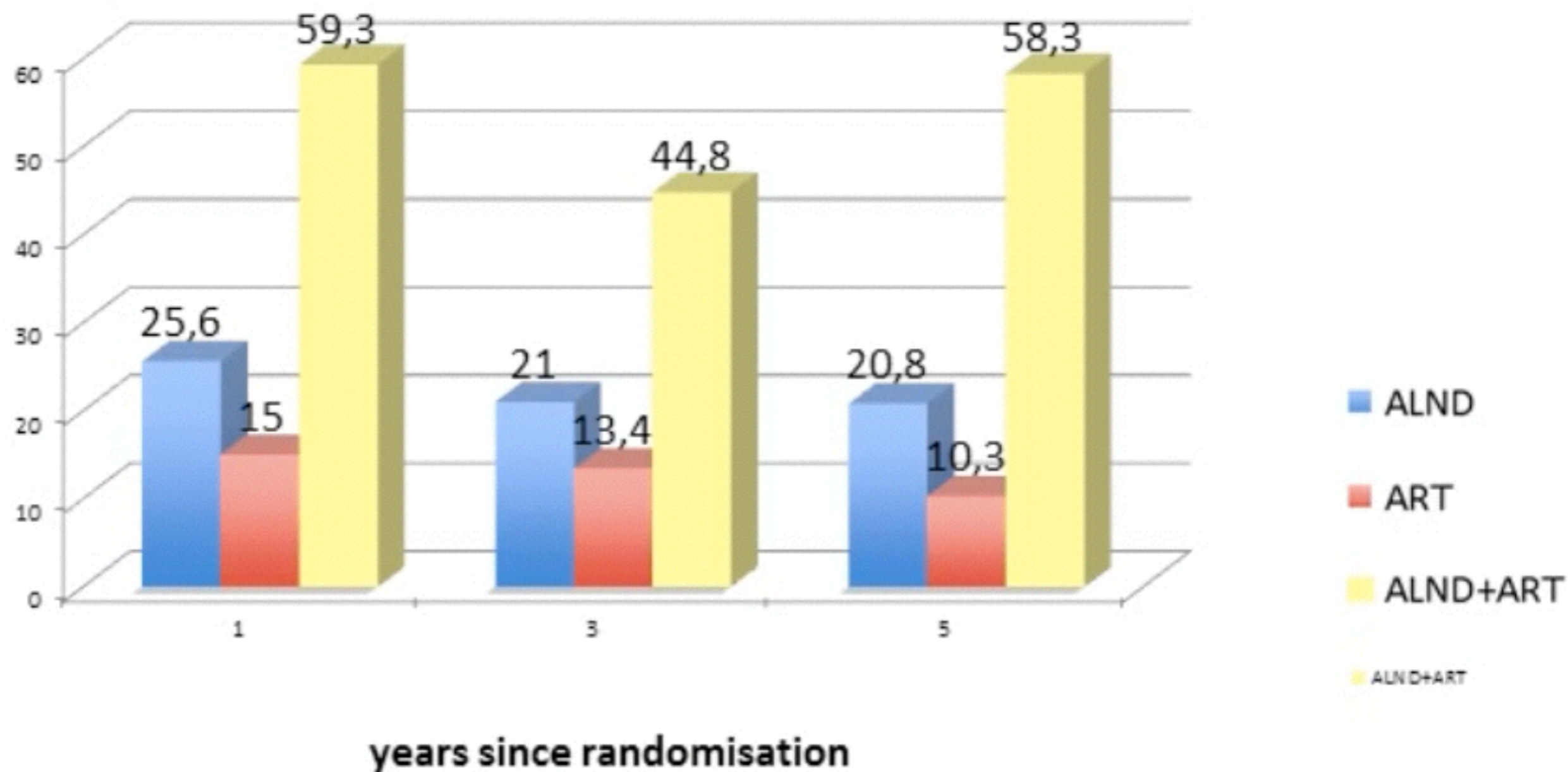

Lymphoedema: arm circumference $\geq 10\%$

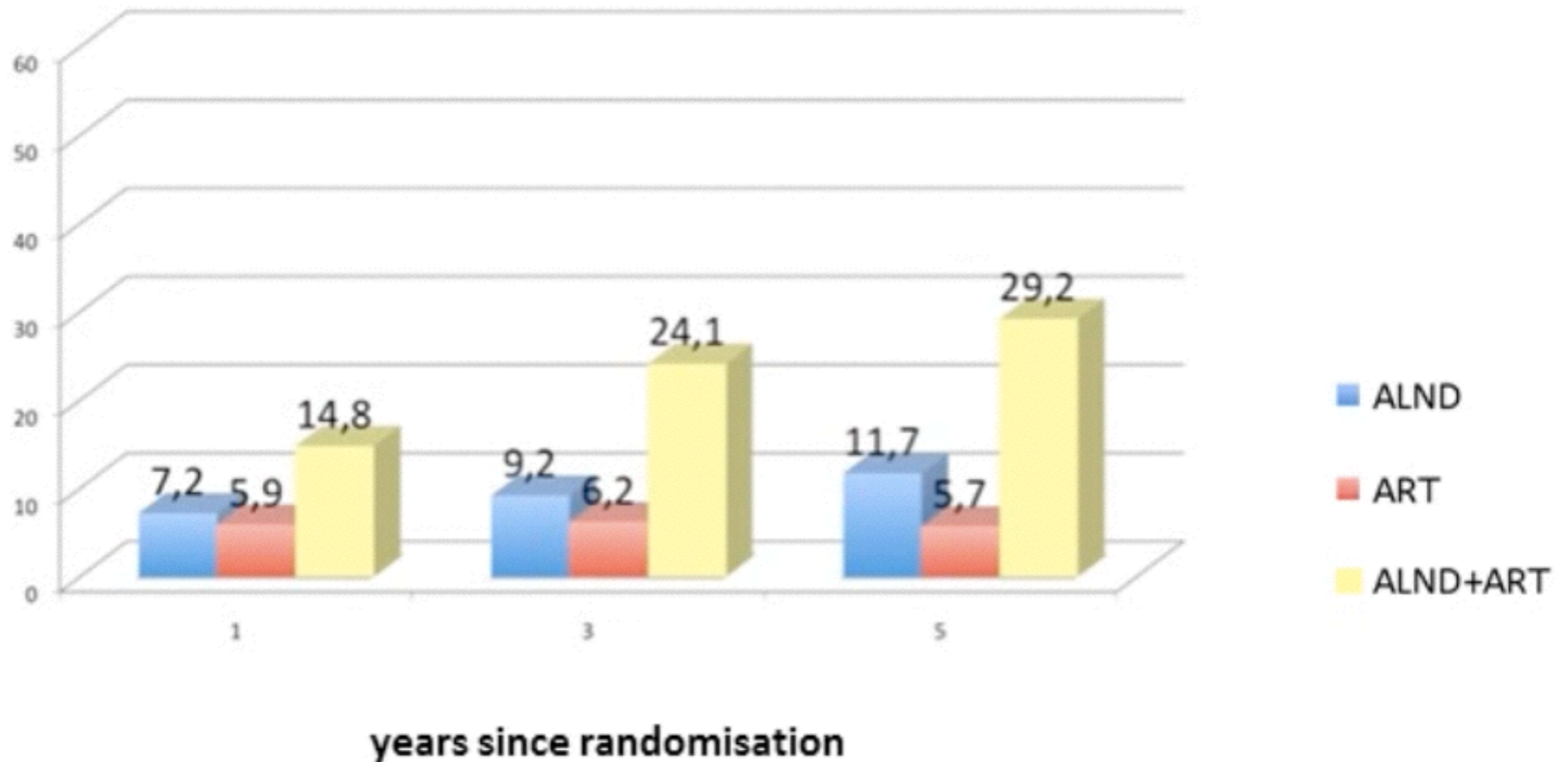

Conclusion

Both ALND and AxRT provide excellent and comparable locoregional control in AxSN+ patients

Significantly less lymphedema after AxRT

AxRT can be considered standard

Objectives

- What is the current management of a positive sentinel node?
 - Discuss Z0011: **IMPERFECT TRIAL THAT HAS BEEN PRACTICE CHANGING**
 - Discuss newer evidence since Z0011: **AMAROS**
 - After total mastectomy: **ACCEPTABLE TO CONSIDER NO ALND IF T1-T2 AND RNI.**

Node positive breast cancer after neoadjuvant therapy

Can sentinel node biopsy be used to avoid node dissection?

...stay tuned for Dr Wright's presentation in 30 minutes!!

Objectives

- Current Indications for axillary node dissection.

Indications for ALND v.2014

- Patients that are **not eligible for SNB**:
 - **T4/Inflammatory breast cancer**
 - **Clinically/biopsy proven node positive disease** (*unless they receive neoadjuvant therapy and SNB is negative?*)
- **Patients with positive SNs** that do not fit Z0011 or AMAROS:
 - **T3**
 - **Mastectomy if PMRT/RNI is not given**
 - **3+ positive SNs or extracapsular invasion >2mm** (*if RNI is not given?*) - Currently favour ALND - Always discussed at multidisciplinary rounds.
 - **Patients who have positive SNs after neoadjuvant therapy** (*TBD by the ALLIANCE A11202 Trial...*)

Objectives

- How does the multidisciplinary team work in Quebec? **MANY DIFFERENT SETTINGS...**

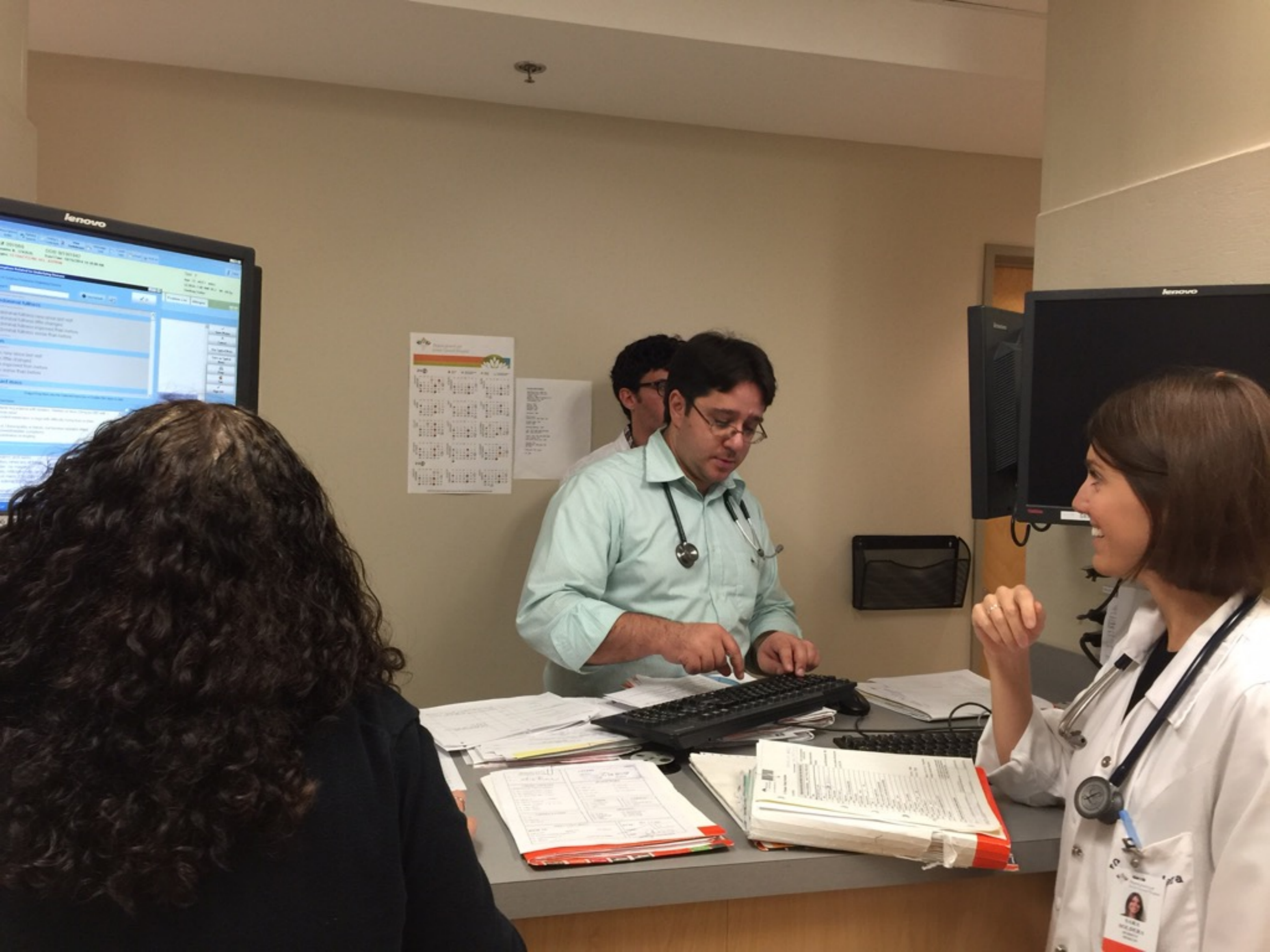

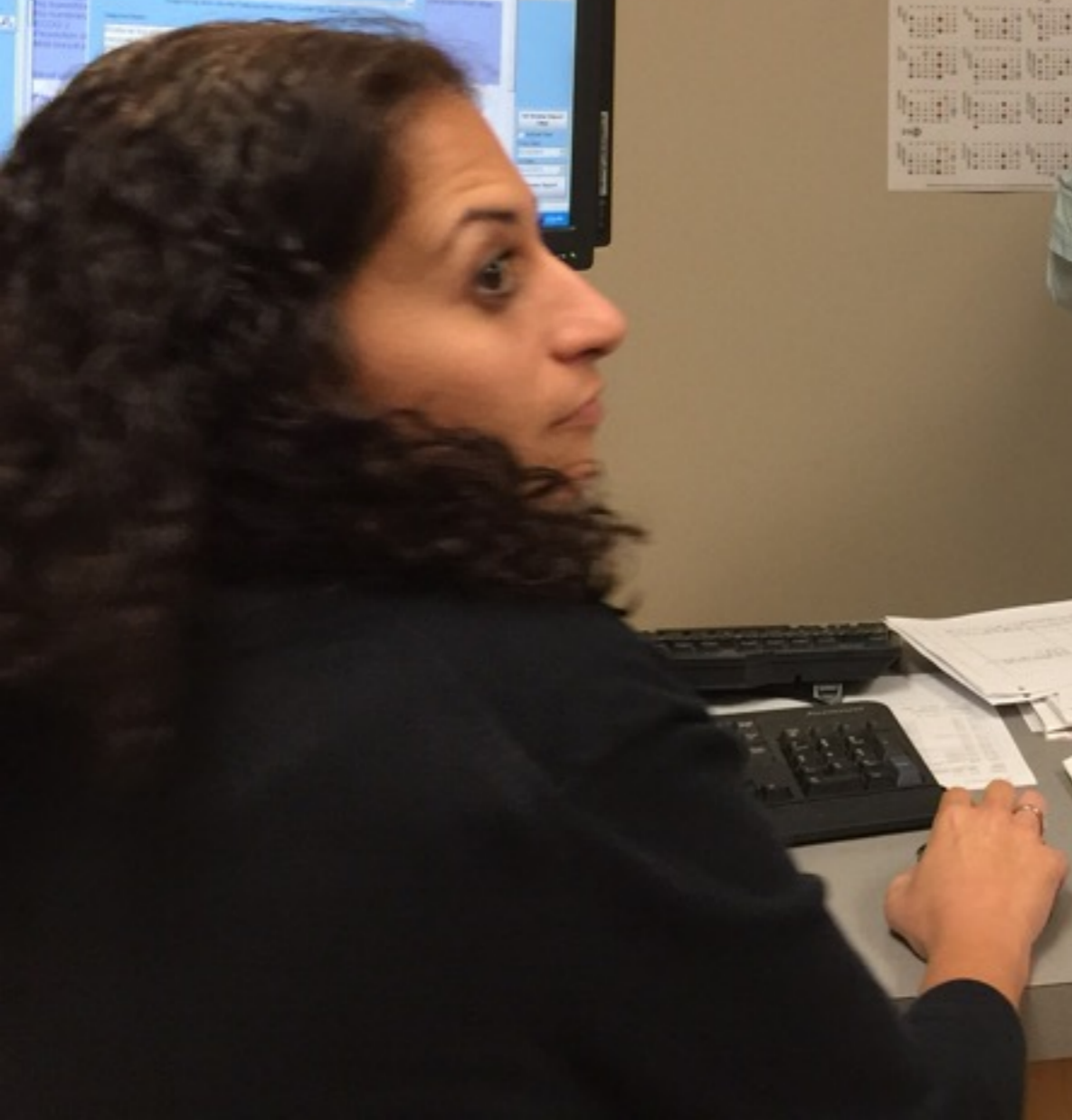
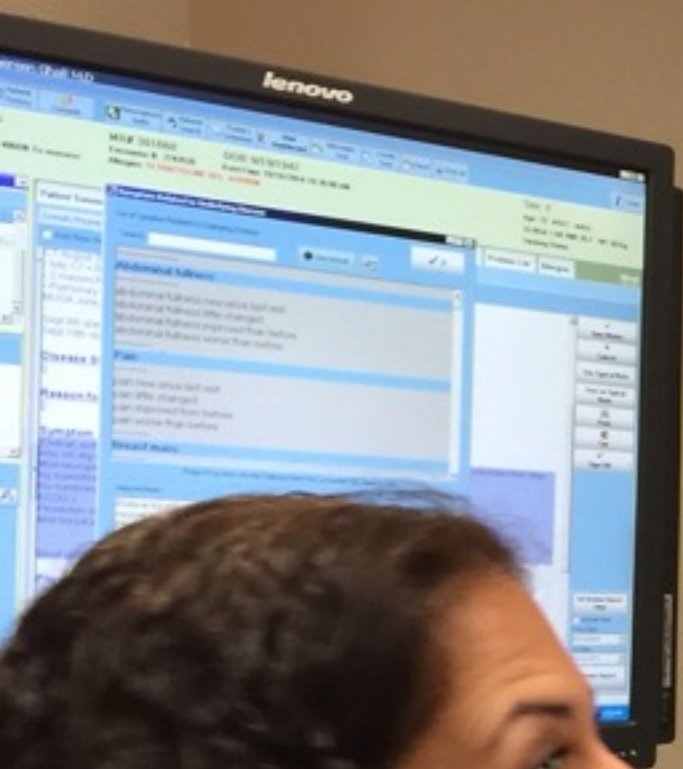

Conclusions

- Since the 1970's, we have been constantly pushing the barriers of the established surgical management of breast cancer - it is unlikely to stop now.
- We are currently witnessing the gradual extinction of surgical axillary node dissection, while there is a marked increase in the loco-regional use of radiotherapy.
- As personalized treatments and targeted therapies become more effective in the future, the need for loco-regional therapies will likely decrease for certain subtypes of breast cancer.
- **Surgeons need to stay vigilant and recognize the situations where axillary node dissection might still be of benefit.**

Appendix

Node positive breast cancer after neoadjuvant therapy

Can sentinel node biopsy be used to avoid node dissection?

SLNB after Neoadjuvant Chemotherapy

Who	Where	What	N	Identification Rate False Negative Rate
Mamounas, E.P.	J Clin Oncol 2005	Unplanned NSABP B-27 Subgroup	428	IR (363/428) = 84.8% FN (15/140) = 10.7%
Gimbergues, P.	Ann Surg Oncol 2008	Series	129	IR (121/129) = 93.8% FN (8/56) = 14.3%
Xing, Y.	Breast J Surg 2006	Meta-analysis	1273	IR (1142/1273) = 88%; FN (65/540) = 12%
Classe, J.M.	J Clin Oncol 2005	Series	195	IR (176/195) = 90%; FN (6/52) = 11.5%

SLNB after Neoadjuvant Chemotherapy in Node Negative Patients

Who	Where	What	N	Identification Rate False Negative Rate
Mamounas, E.P.	J Clin Oncol 2005	Unplanned NSABP B-27 Subgroup	326	IR (275/326) = 84.4%; FN (12/97) = 12.4%
Gimbergues, P.	Ann Surg Oncol 2008	Series	82	IR (77/82) = 93.9% FN (0/29) = 0%
Kinoshita, T.	Breast Cancer 2007	Series, node negative NAC	104	IR (97/104) = 93.4%; FN (4/40) = 10.0%
Classe, J.M.	J Clin Oncol 2005	Series	130	IR (123/130) = 94.6%; FN (3/40) = 7.5%

SLNB after Neoadjuvant Chemotherapy in Node Positive Patients

Who	Where	How (were positive nodes determined)	N	Identification Rate False Negative Rate
Mamounas, E.P.	J Clin Oncol 2005	Clinical	102	IR (88/102) = 86.3% FN (3/43) = 7.0%
Gimbergues, P.	Ann Surg Oncol 2008	Clinical	47	IR (44/47) = 93.7% FN (8/27) = 29.6%
Lee, S.	Breast Cancer Res Treat 2007	Clinical and Radiological	219	IR (170/219) = 77.6% FN (7/124) = 5.6%
Classe, J.M.	J Clin Oncol 2005	Clinical	65	IR (53/65) = 81.5%; FN (3/25) = 12%
Newman, E.A.	Ann Surg Oncol 2007	Biopsy Proven	40	IR (40/40) = 100%; FN (3/28) = 11%
Shen, J.	Cancer 2007	Biopsy Proven	69	IR (64/69) = 92.8% FN (10/40) = 25%

Sentinel Node biopsy Following NeoAdjuvant Chemotherapy in biopsy proven node positive breast cancer: The **SN FNAC** study.

Boileau JF, Poirier B, Basik M, Holloway C, Gaboury L, Sideris L, Meterissian S, Arnaout A, Brackstone M, McCready DR, Karp S, Wright F, Younan R, Provencher L, Patocskai E, Omeroglu A, Robidoux A. *Montreal Jewish General Segal Cancer Centre – McGill University, Hopital Saint-Sacrement – Universite Laval, Sunnybrook Odette Cancer Centre – University of Toronto, Centre Hospitalier de l'Universite de Montreal, Hopital Maisonneuve Rosemont, McGill University Health Centre, Ottawa Hospital, London Health Sciences Centre, University Health Network, Lahey Clinic.*

A study funded by the Quebec Breast Cancer Foundation, the Cancer Research Society, the Week-end to End Women's Cancer and the Montreal Jewish General Segal Cancer Centre.

SN FNAC Trial

- 1/3 of patients will have a pathologic complete axillary response to neoadjuvant therapy.
- Can we identify which patients have residual disease after neoadjuvant therapy using sentinel node biopsy?

SN FNAC – Study design

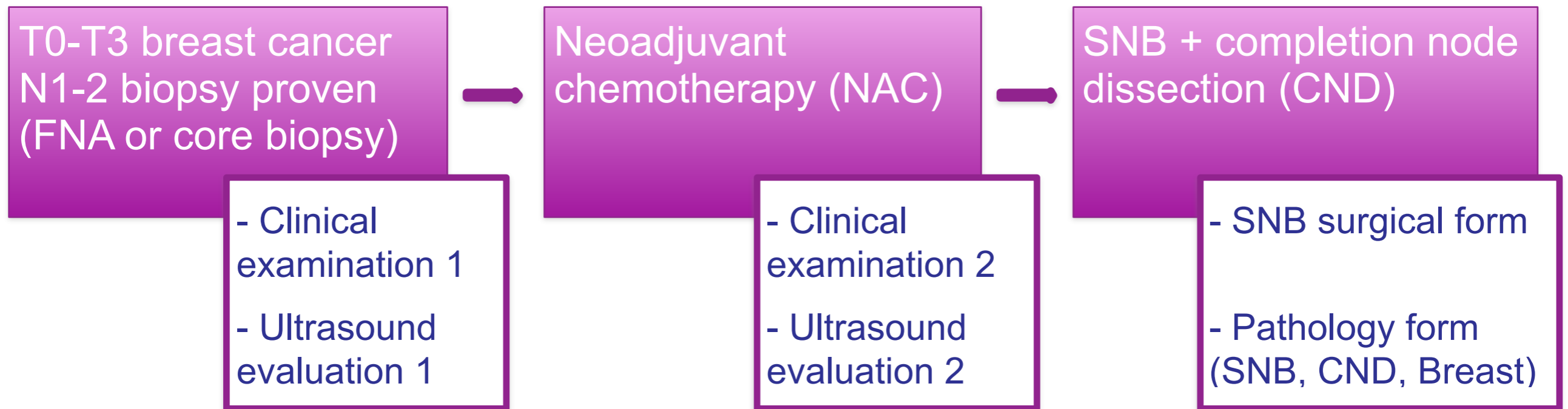

N=153

Methods

- SNB surgery :
 - Radiocolloid marked with Tc99 mandatory.
 - Blue dye optional.
- SNB pathology :
 - Nodes sliced $\leq 2\text{mm}$.
 - IHC used if H&E was negative.
 - Pathology (SNB + CND slides) reviewed centrally.

* Sentinel nodes (SNs) with metastases of any size (ypN0(i+), ypN1mi and ypN1) were considered as positive.

IHC: Immunohistochemistry
H&E: Hematoxylin and eosin stain

Results

Table 3. Size of SN metastasis

SNs with metastases < 0.2mm: positive vs. negative	FNR	NPV	Accuracy
ypN0(i+) SN = node positive	<u>8.4%</u> <u>(7/83)</u>	86.3% (44/51)	94.5% (120/127)
ypN0(i+) SN = node negative	13.3% (11/83)	80.0% (44/55)	91.3% (116/127)

FNR = False negative rate
NPV = Negative predictive value

The rate of positive non-SNs is independent of the size of SN metastases after NAT.

Size of largest SN metastasis	ypN0(i+) ≤ 0.2 mm	ypN1mi > 0.2 – 2 mm	ypN1 > 2 mm
Rate of positive non-SNs at CND	57% (4/7)	38% (3/8)	56% (34/61)

P=NS

Results

Table 2. False negative SNB: Number of positive axillary nodes

False negative patient #	Positive SNs/ Total SNs	Positive nodes CND/ Total nodes CND
#1	0/2	1/13
#2	0/3	1/3
#3	0/1	1/9
#4	0/1	1/15
#5	0/1	1/19
#6	0/2	1/7
#7	0/1	3/8

Results

Table 4. Number of SNs removed

Number of SNs removed	FNR	NPV	Accuracy
1 SN removed	18.2% (4/22)	71.4% (10/14)	87.5% (28/32)
2+ SNs removed	4.9% (3/61)	91.9% (34/37)	96.8% (92/95)

FNR = False negative rate
NPV = Negative predictive value

Results

Table 5. Accuracy clinical examination vs. US vs. SNB

Modality	FNR	NPV	Accuracy
Clinical examination	82%	38%	45%
Ultrasound	47%	48%	62%
Sentinel node biopsy	8%	86%	94%

FNR = False negative rate
NPV = Negative predictive value

Conclusions

- The accuracy (94.5%) and FNR (<10%) of SNB after NAC in biopsy proven node positive breast cancer is acceptable and similar to that seen for patients that present with clinically negative nodes in the absence of neoadjuvant therapy.
- The technical success rate of SNB in this setting (87.6%) is slightly inferior to 90%. In the presence of a technical failure, axillary node dissection is warranted.
- SNB is more accurate than both clinical examination and ultrasound evaluation of the axilla.

Conclusions

- Following NAC, SNs with metastases of any size should be considered as positive.
- The accuracy of SNB is increased when more than one node is removed.
- Axillary node dissection could potentially be avoided in 1/3 of patients that present with node positive breast cancer by using SNB after NAC.
- In an era where regional nodal radiation is increasingly used, the relevance of leaving residual disease in the undissected axilla of patients after NAC is unknown and remains to be investigated.

The role of sentinel lymph node surgery in patients presenting with node positive breast cancer (T0-T4, N1-2) who receive neoadjuvant chemotherapy – results from the ACOSOG Z1071 trial

Judy Boughey, Vera Suman, Elizabeth Mittendorf, Gretchen Ahrendt, Lee Wilke, Bret Taback, Marilyn Leitch, Teresa Flippo-Morton, David Byrd, David Ollila, Tom Julian, Sarah McLaughlin, Linda McCall, Fraser Symmans, Carisa Le-Petross, Bruce Haffty, Tom Buchholz, Kelly Hunt

Z1071 schema

T0-4, N1-2, M0 invasive breast cancer
(pretreatment axillary ultrasound with FNA or core biopsy documenting axillary metastases)

REGISTER*

Neoadjuvant chemotherapy

REGISTER*

SLN and ALND

ACOSOG Z1071

Hypothesis: SLN surgery is an accurate method of axillary staging after NAC in node positive patients

Primary Endpoint: False negative rate of SLN surgery in patients with node positive disease at presentation with at least 2 SLNs examined after NAC 

ClinicalTrials.gov Identifier: NCT00881361

level I and II nodes, which would have been detected by palpation if ALND was performed prior to preoperative chemotherapy, but may no longer be palpable after completion of preoperative chemotherapy.

1.4 Objectives

Primary and secondary objectives will be carried out in patients with clinical N1 disease independently of patients with clinical N2 disease.

1.4.1 Primary Objective

To determine the false negative rate for SLN surgery. Among the patients who have at least one sentinel lymph node identified and removed, false negative rate is defined as the number of patients declared to have no evidence of cancer in the SLN *and* are found to have at least one positive lymph node in the ALND divided by the total number of patients with at least one positive axillary lymph node by ALND.

1.4.2 Secondary Objectives

1. To determine how the axillary ultrasound status of the patient upon completion of preoperative chemotherapy (evidence of residual lymphadenopathy on the ultrasound examination versus no evidence of lymphadenopathy in the ultrasound examination) affects the false negative rate of SLN and how sonographic findings correlate with residual disease on final pathology.
2. To determine the node status of patients after preoperative chemotherapy. Patients will be classified as node positive if they were determined to have at least one positive lymph node by SLN or ALND. Patients will be classified as node negative if all nodes examined by SLN and ALND were negative.
3. To determine whether the false-negative rate for SLN surgery after preoperative chemotherapy is related to the extent of residual cancer burden (RCB) overall, or separately in the breast or regional nodal basin.
4. To evaluate pathological complete response (pCR) rates (defined as no invasive disease in breast or lymph nodes) and disease-free survival (DFS) rates in node positive patients receiving preoperative chemotherapy.

Methods

Recommended surgical standards

- Resection of minimum of 2 SLNs
- Use of dual tracer (radiocolloid and blue dye)

Pathologic assessment

- Standard processing with H&E staining
- Node positive defined as tumor >0.2mm on H&E

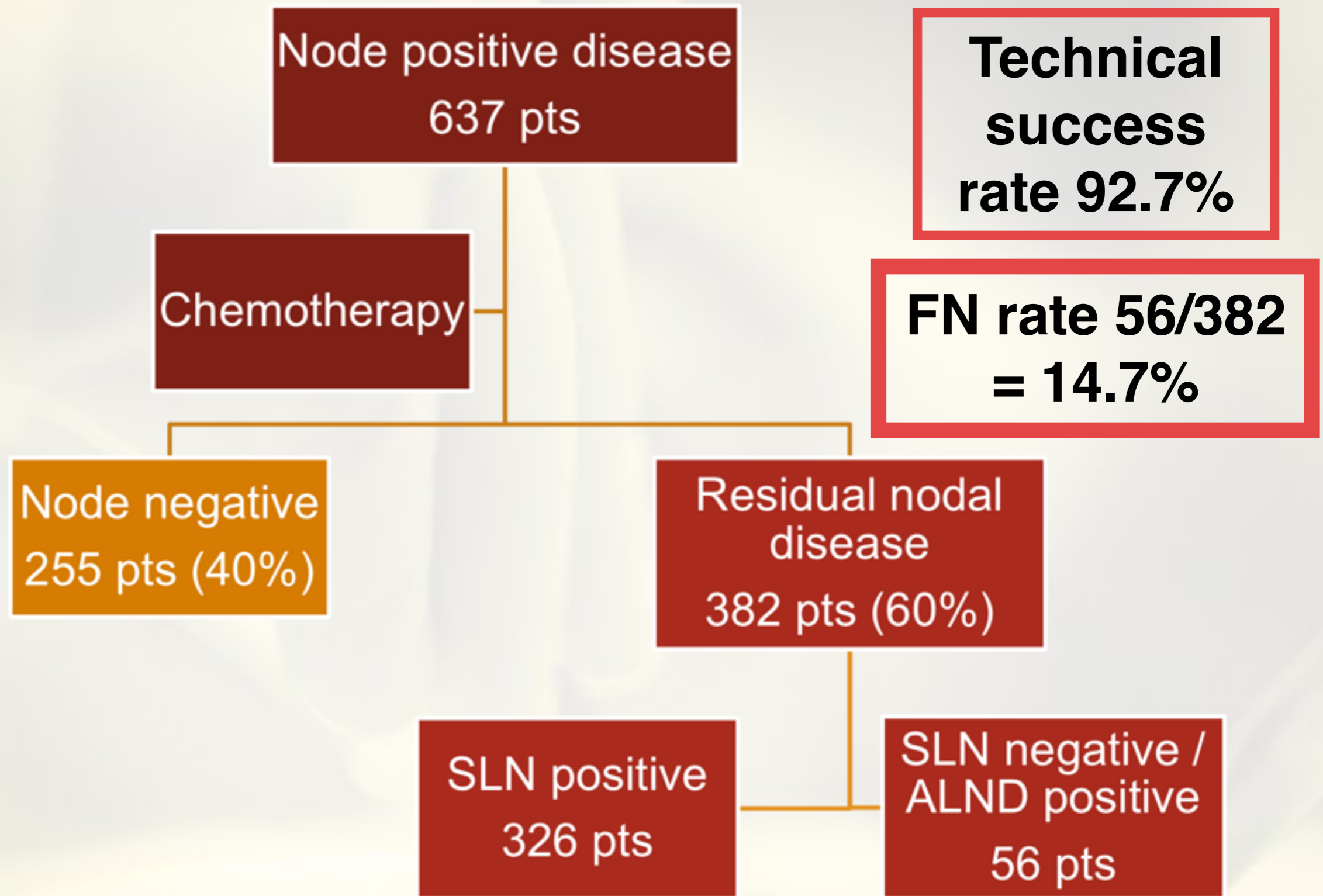

SLN correctly identified nodal status in 91.2%

False negative rate among pts with cN1 disease and at least 2 SLNs examined

$$\text{FNR} = \frac{\# \text{ pts SLN - / ALND +}}{\# \text{ pts SLN + or ALND +}}$$

310 patients had residual nodal disease

39 of these patients had negative SLNs

$$\text{FNR} = 12.6\%$$

95% probability that the FNR lies in the range of 9.4 to 16.7%.

Only 1 SLN identified

78 patients with cN1 had only 1 SLN examined

24 pts had no residual nodal disease

17 of the 54 pts with residual nodal disease had false negative SLN findings

FNR = 31.5%

ACOSOG Z1071

CONCLUSIONS AND RELEVANCE Among women with cN1 breast cancer receiving neoadjuvant chemotherapy who had 2 or more SLNs examined, the FNR was not found to be 10% or less. Given this FNR threshold, changes in approach and patient selection that result in greater sensitivity would be necessary to support the use of SLN surgery as an alternative to ALND.

Can sentinel node biopsy accurately stage the axilla after NAT in patients with biopsy proven node positive axilla?

Who	Where	How (were positive nodes determined)	N	N0(i+) SN's considered as positive	Identification Rate False Negative Rate
Boughey, J.	SABCS 2012	Biopsy Proven	756	no	IR (639/689) = 92.7% FN (56/382) = 14.7%
Boileau, JF.	ASCO 2013	Biopsy Proven	153	yes	IR (127/145) = 87.6% FN (7/83) = 8.4%

Beyond 2014....

Future Studies

ALLIANCE A11202 Schema

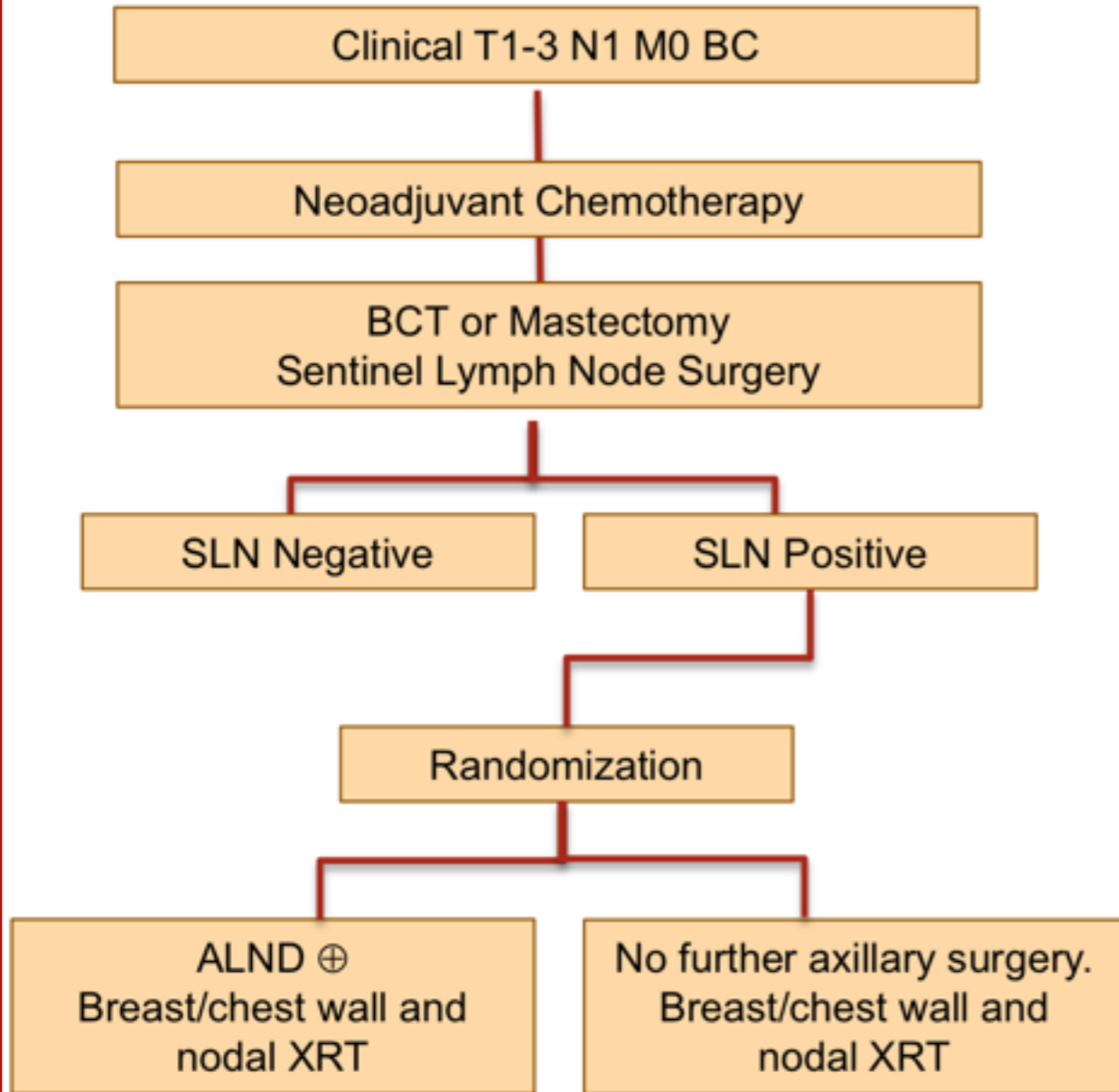

NSABP B-51/RTOG 1304 (NRG 9353) Schema

